

# ADD/MODIFY DETAILS – Details Configuration

Modified on: Sun, 27 Sep, 2020 at 4:30 PM

## Add/Modify Details

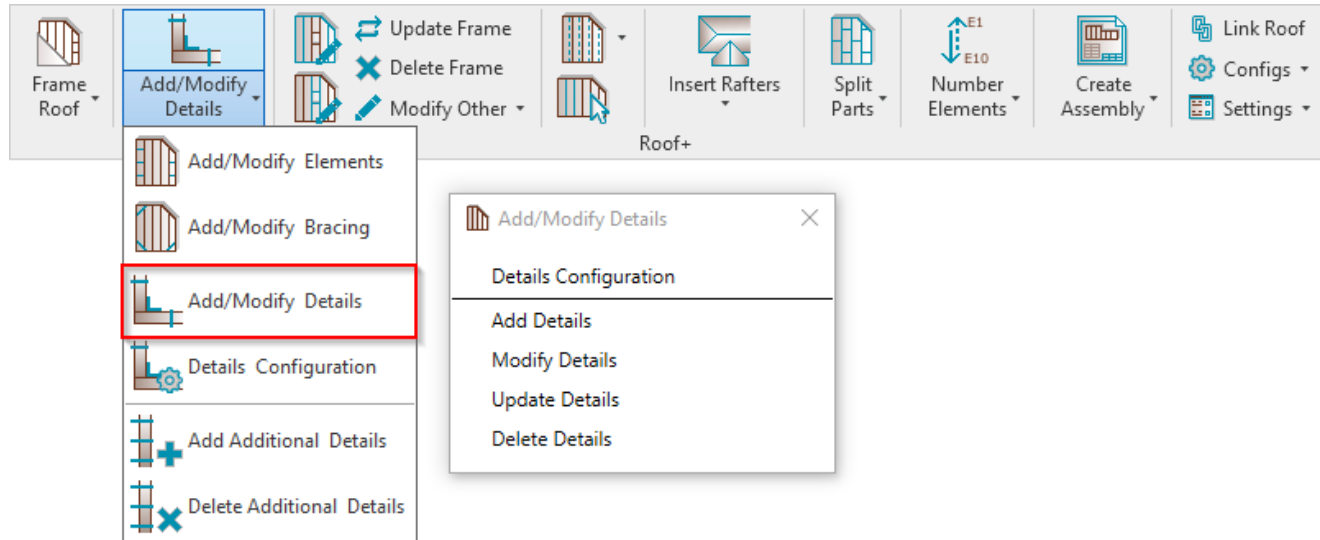

**Add/Modify Details** – for placing details in the frame. It is recommended to use these functions at the end of the framing process.

## Details Configuration

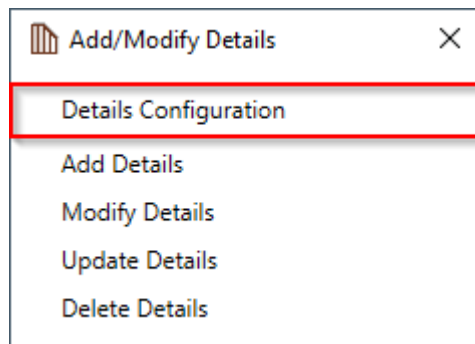

**Details Configuration** – definition of all detail-placing parameters.

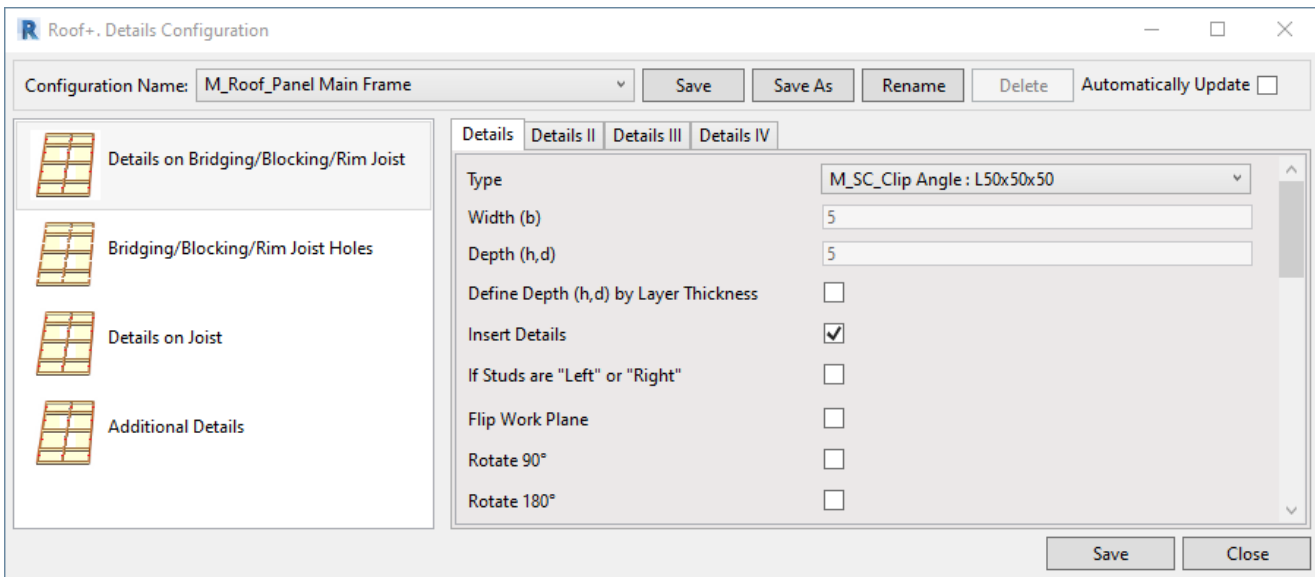

**Configuration Name** – configuration with all framing settings. You can use sample configurations or create new ones. Also you can rename or delete existing configurations.

By default, **Roof+** detail configurations are saved in *C:\Users\user name\AppData\Roaming\Tools 4 Revit\Roof+2021 Configurations (or other version)\Details Configurations\Metric or Imperial* catalog. The content from this catalog can be copied to other users' computers if needed. Also the path can be changed in **Roof+** → **Settings** → **Configuration Files' Location**.

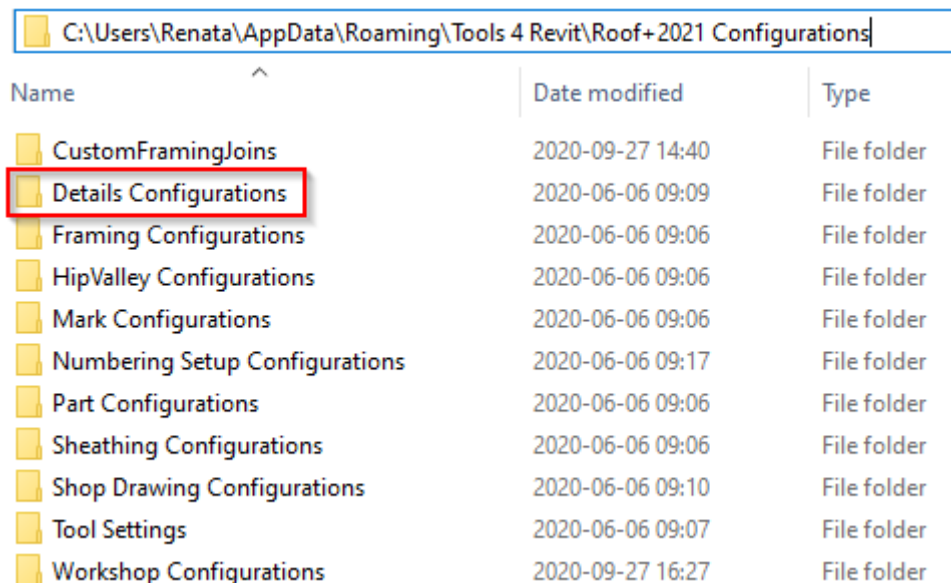

**Details on Bridging/Blocking/Rim Joist, Details on Joist and Bridging/Blocking/Rim Joist Holes**

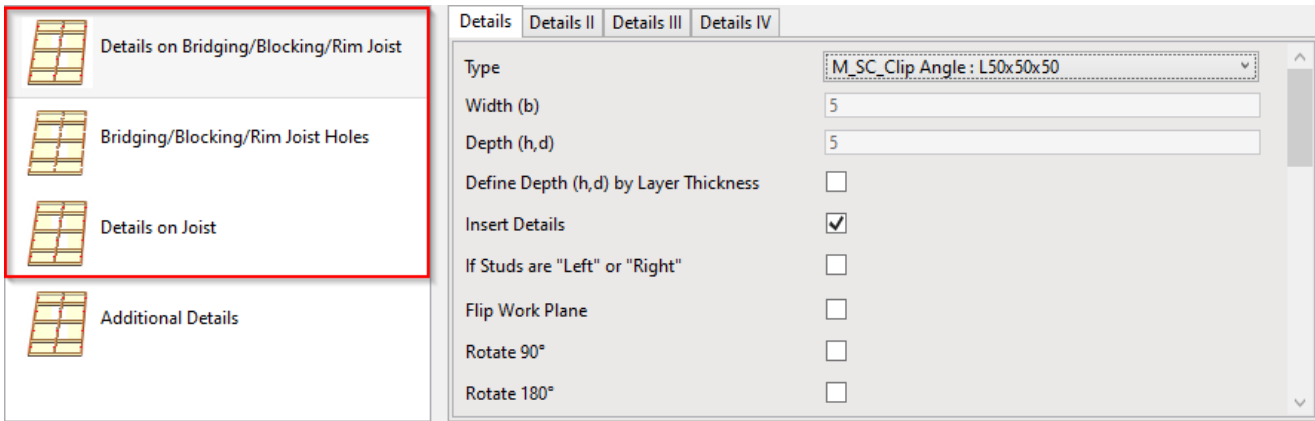

**Details on Bridging/Blocking/Rim Joist, Details on Joist and Bridging/Blocking/Rim Joist Holes** – different rules for placing details and holes.

You can very easily predefine different insertion rules for 4 detail families using the 4 tabs across the top of the dialog.

### Type and Define Depth (h,d) by Layer Thickness

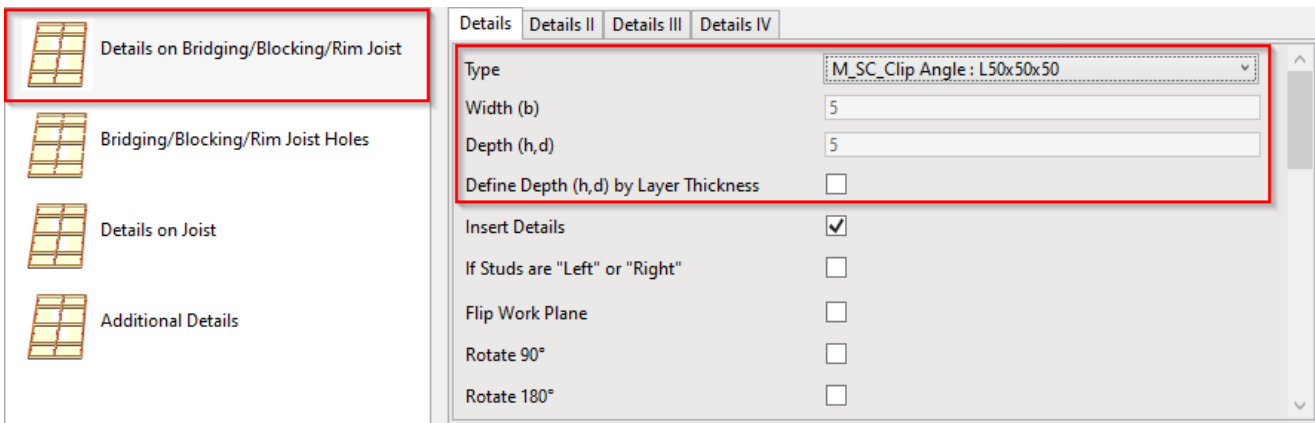

**Type** – select a family and type of the detail.

Sample detail and hole families (Metric or Imperial), which come with **Roof+**:

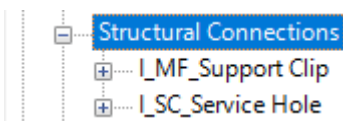

**Width (b)** – shows the width, b parameter value from selected family type.

**Depth (h, d)** – shows the depth, h or d parameter value from selected family type.

**Define Depth (h, d) by Layer Thickness** – the software will create new type for selected family and change depth value to the roof layer thickness. So the details or holes will fit the layer in the roof.

### Insert Details

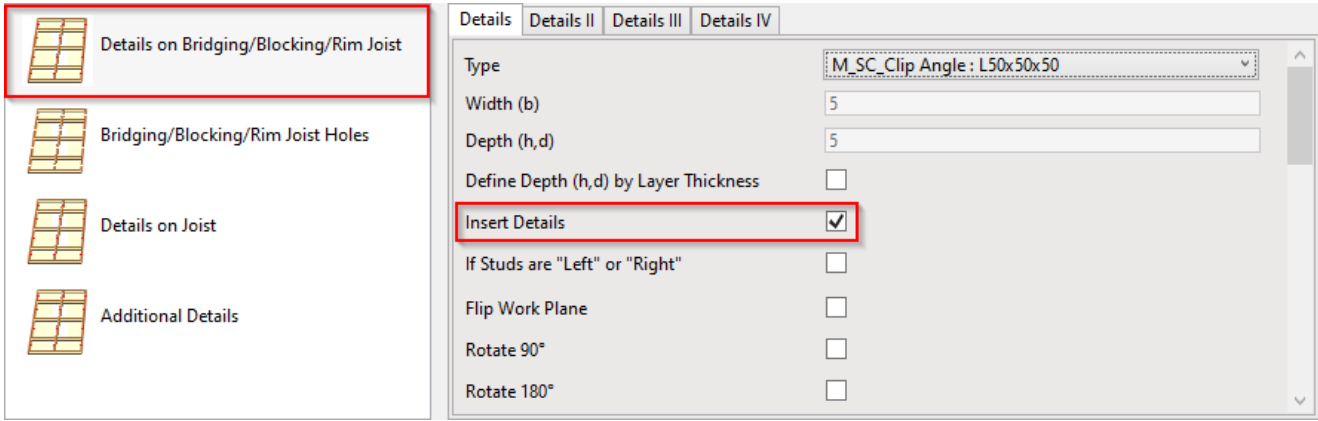

**Insert Details** – the details or holes with rules that are listed below will be (not) applied in the frame. You can predefine the rules for the details, but it will not necessarily have to be added during the current insertion process.

**Rotate 90°, 180°**

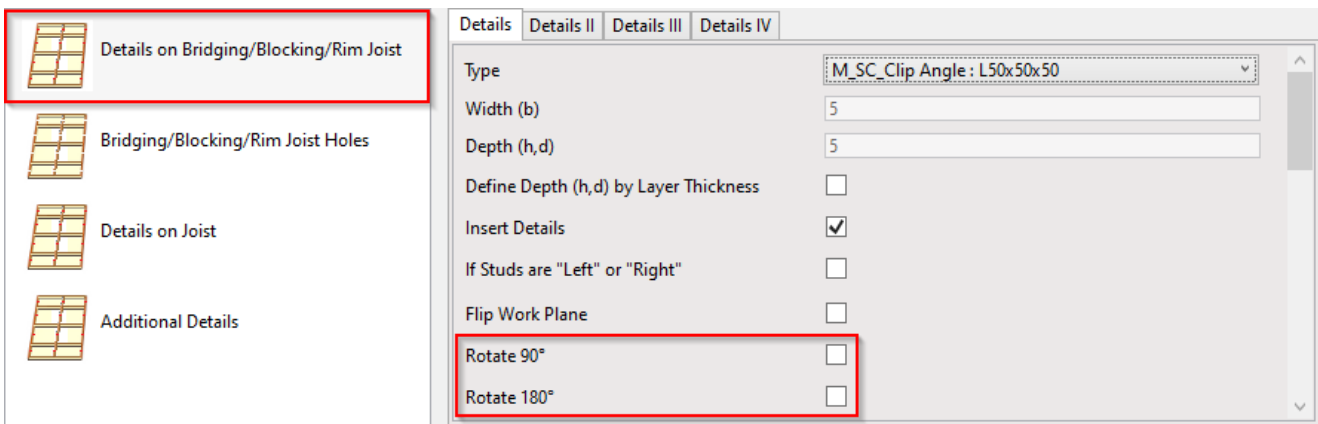

**Rotate 90°, 180°** – if ON, then rotates detail by 90 or 180 degrees. Rotation depends on how the family is created.

**Offset from Joist Side**

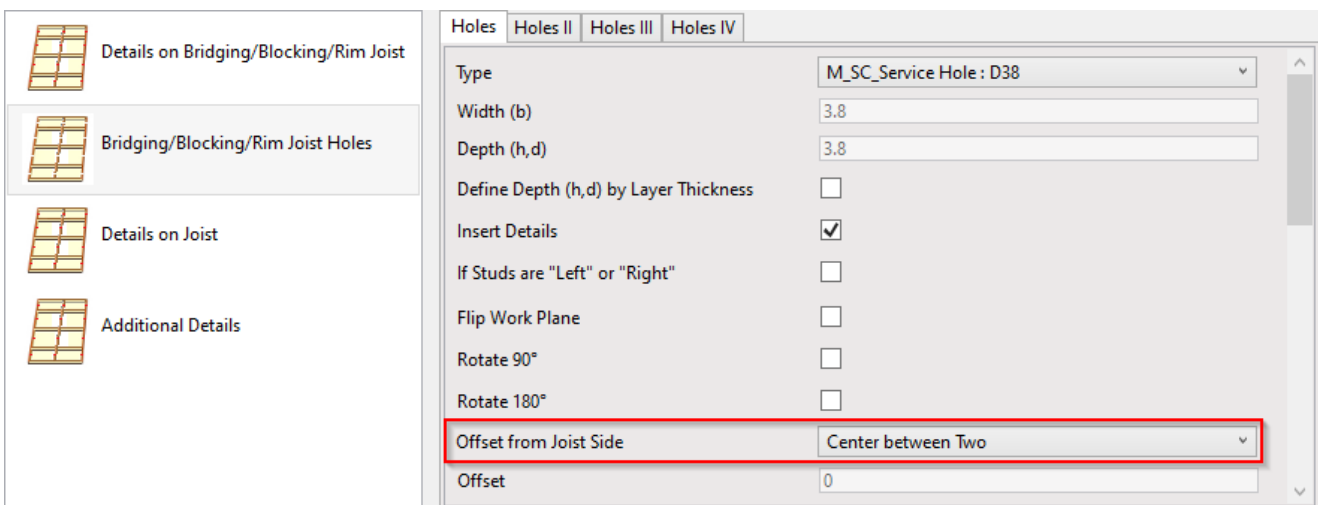

**Offset from Joist Side** – detail insertion placement: **Left, Right, Left and Right, or Center between Two.**

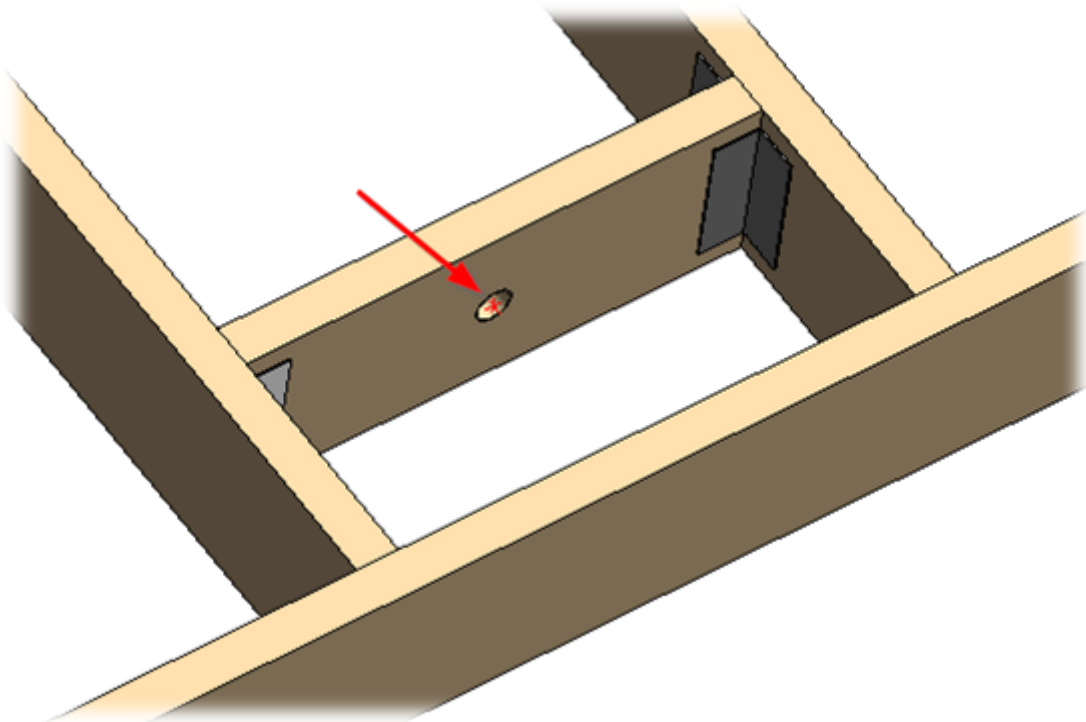

*Example: when clip angle is inserted on Left and Right sides:*

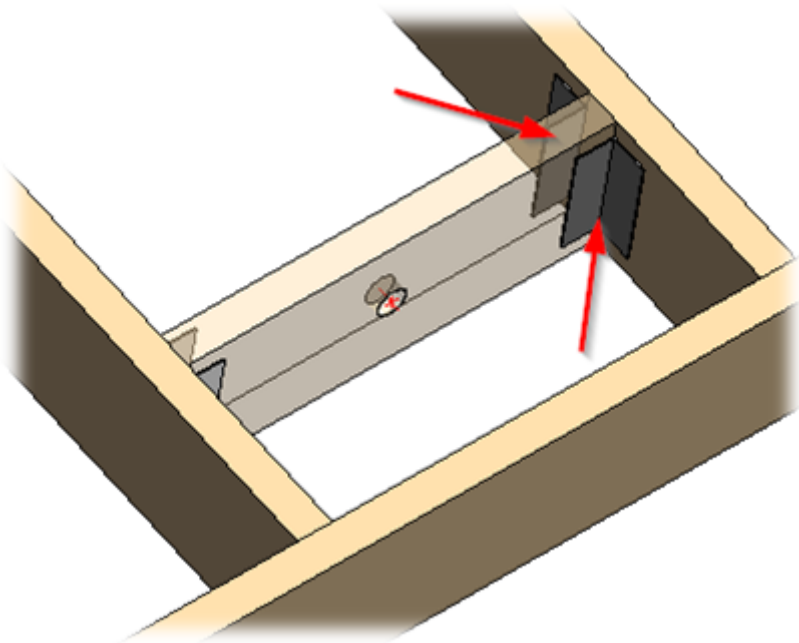

**Offset**



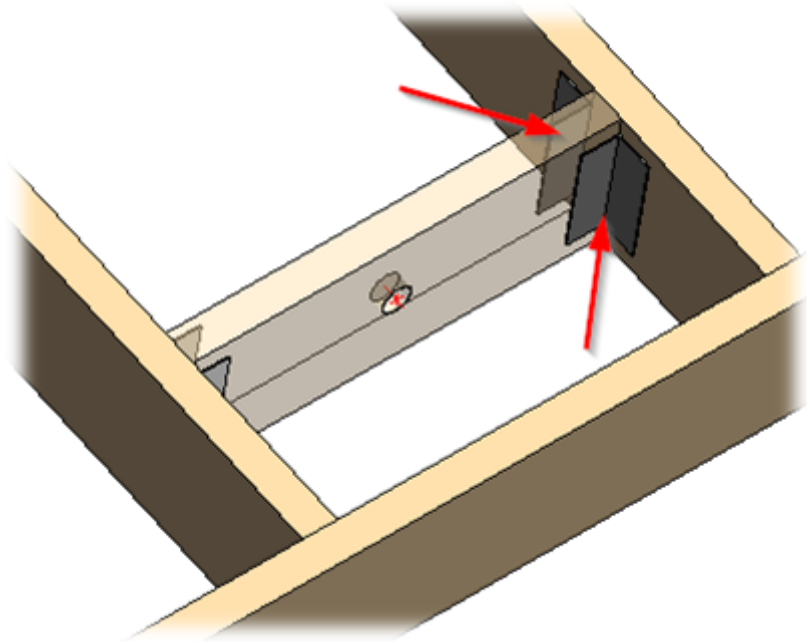

Details	Details II	Details III	Details IV
Type			
MH_Support Face_Bottom Edge_Hanger : 45x120			
Width (b)			
4.5			
Depth (h,d)			
20			
Define Depth (h,d) by Layer Thickness			
<input type="checkbox"/>			
Insert Details			
<input checked="" type="checkbox"/>			
If Studs are "Left" or "Right"			
<input type="checkbox"/>			
Flip Work Plane			
<input type="checkbox"/>			
Rotate 90°			
<input type="checkbox"/>			
Rotate 180°			
<input type="checkbox"/>			
Offset from Element Side			
Left			
Offset			
0			

**Offset** – distance between detail and a joist.

*Example: when clip angle is inserted on **Left and Right** sides with **Offset = 0**:*







**Measure from Location Line/Web Faces**

Details		Details II	Details III	Details IV
	Details on Bridging/Blocking/Rim Joist	Type	MH_Support Face_Bottom Edge_Hanger : 45x120	
	Bridging/Blocking/Rim Joist Holes	Width (b)	4.5	
	Details on Joist	Depth (h,d)	20	
	Additional Details	Define Depth (h,d) by Layer Thickness	<input type="checkbox"/>	
		Insert Details	<input checked="" type="checkbox"/>	
		If Studs are "Left" or "Right"	<input type="checkbox"/>	
		Flip Work Plane	<input type="checkbox"/>	
		Rotate 90°	<input type="checkbox"/>	
		Rotate 180°	<input type="checkbox"/>	
		Offset from Element Side	Left	
		Offset	0	
		Measure from Location Line	<input checked="" type="checkbox"/>	
		Measure from Web Faces	<input type="checkbox"/>	

**Measure from Location Line** – if ON, then the distance for detail placement will be calculated from the Bridging/Nogging/Blocking/Joist location line.

**Measure from Web Faces** – if ON, then the distance for detail placement will be calculated from the Bridging/Nogging/Blocking/Joist web faces.

## Location

Details		Details II	Details III	Details IV
	Details on Bridging/Blocking/Rim Joist	Measure from Joist Web Faces	<input type="checkbox"/>	
	Bridging/Blocking/Rim Joist Holes	Location on Rim Joists 2	Front Face Bottom Edge	
	Details on Joist	Location on Top Cover Plates	None	
	Additional Details	Location on Rim Joists 1	Rear Face Bottom Edge	
		Location on Bottom Pad Plates	None	
		Include Sloped Rim Joists	<input checked="" type="checkbox"/>	
		Only on Sloped Rim Joists	<input type="checkbox"/>	
		Location on Bridging/Nogging/Blocking	None	
		Location on Additional Bridging/.../Blocking	None	
		Location on Header 2	Rear Face Bottom Edge	
		Location on Header 1	Front Face Bottom Edge	
		Include Openings	<input checked="" type="checkbox"/>	
		Min. Distance between Joists	50	

**Location** settings – predefine detail position on top/bottom rim joists/cover plates, bridgings/noggings, headers, etc.



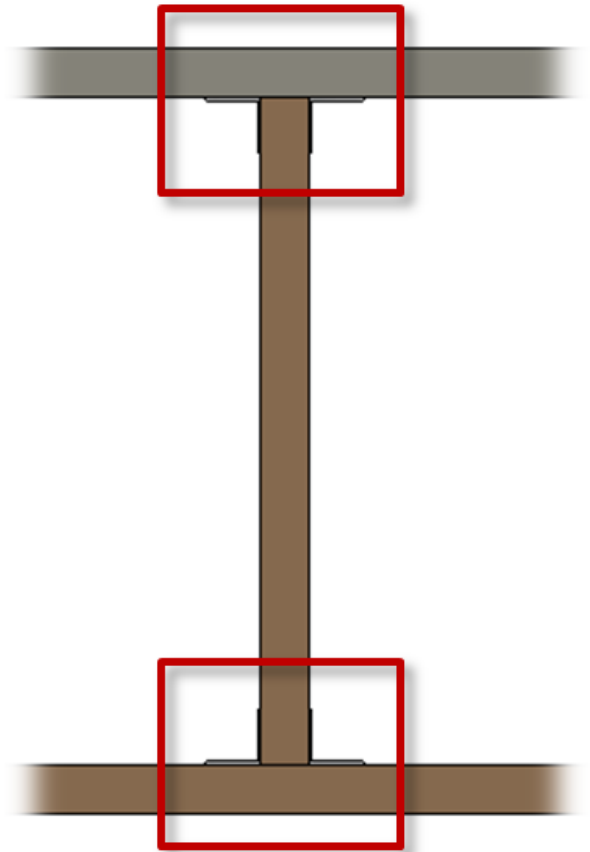

Possible options:

- Front Face
- Front Face
- Front Face Top Edge
- Front Face Bottom Edge
- Top Face
- Bottom Face
- None
- Rear Face
- Rear Face Top Edge
- Rear Face Bottom Edge



### Include Openings





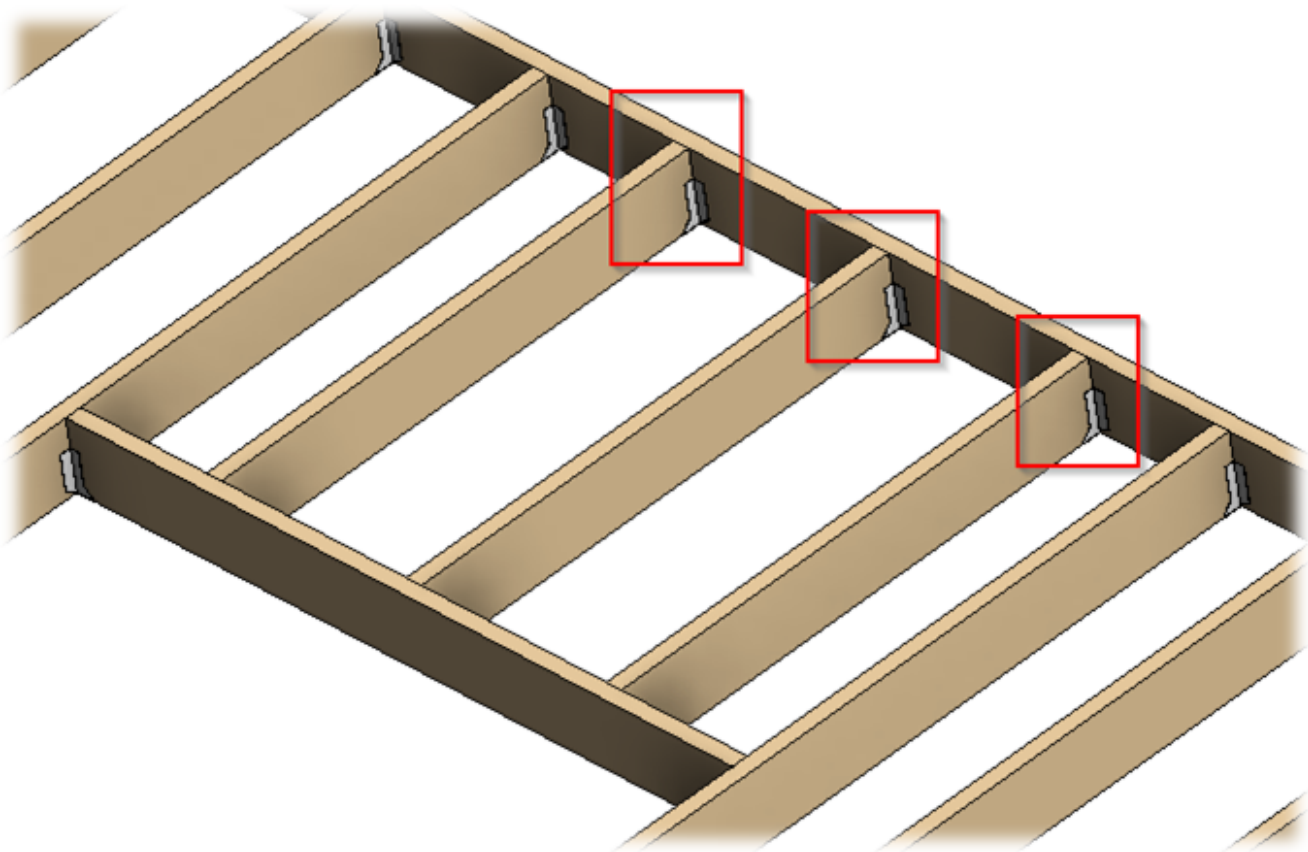

Details		Details II	Details III	Details IV
	Details on Bridging/Blocking/Rim Joist			
	Bridging/Blocking/Rim Joist Holes			
	Details on Joist			
	Additional Details			
	Measure from Joist Web Faces	<input type="checkbox"/>		
	Location on Rim Joists 2		Front Face Bottom Edge	
	Location on Top Cover Plates		None	
	Location on Rim Joists 1		Rear Face Bottom Edge	
	Location on Bottom Pad Plates		None	
	Include Sloped Rim Joists	<input checked="" type="checkbox"/>		
	Only on Sloped Rim Joists	<input type="checkbox"/>		
	Location on Bridging/Nogging/Blocking		None	
	Location on Additional Bridging/.../Blocking		None	
	Location on Header 2		Rear Face Bottom Edge	
	Location on Header 1		Front Face Bottom Edge	
	<b>Include Openings</b>	<input checked="" type="checkbox"/>		
	Min. Distance between Joists		50	

**Include Openings** – if ON, then the details will be inserted on elements above and below the openings.



### Min Distance between Joists



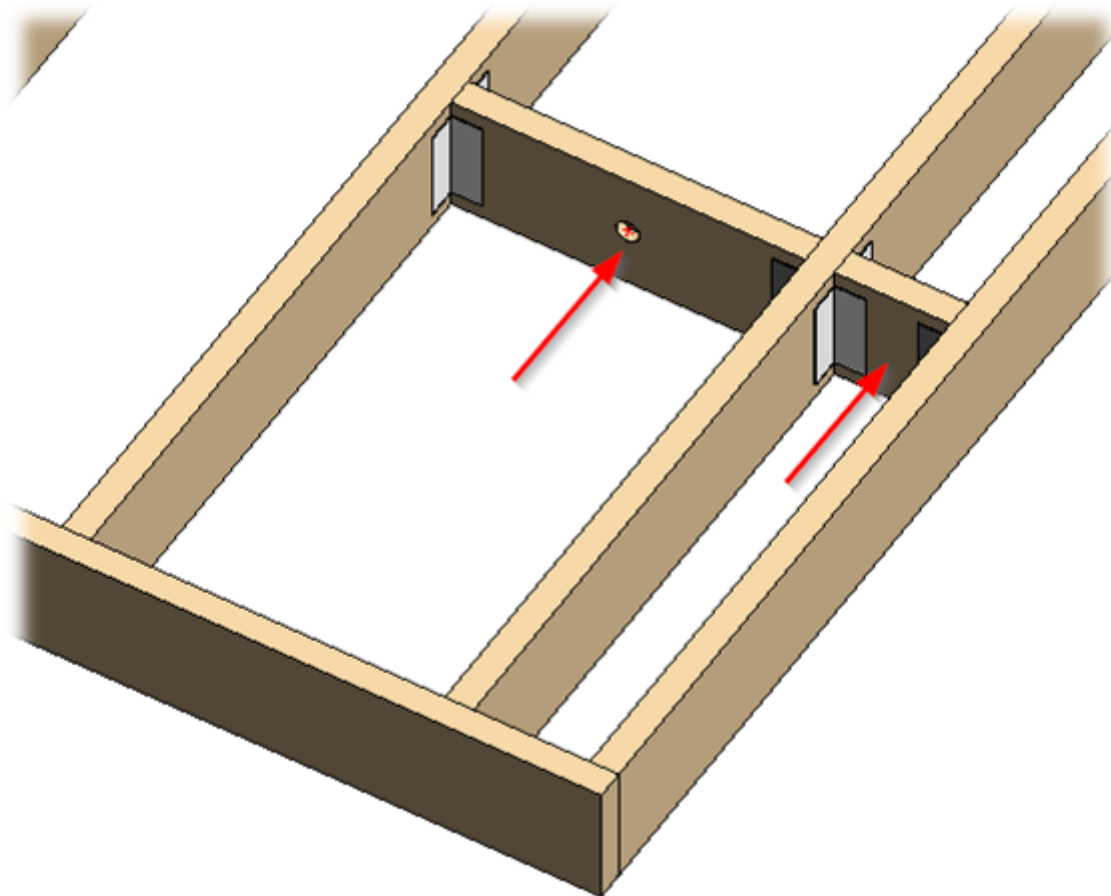

		Holes	Holes II	Holes III	Holes IV
	Details on Bridging/Blocking/Rim Joist				
	Bridging/Blocking/Rim Joist Holes				
	Details on Joist				
	Additional Details				
		Location on Bottom Pad Plates	None		
		Include Sloped Rim Joists	<input type="checkbox"/>		
		Only on Sloped Rim Joists	<input type="checkbox"/>		
		Location on Bridging/Nogging/Blocking	Front Face		
		Location on Additional Bridging/.../Blocking	Front Face		
		Location on Header 2	None		
		Location on Header 1	None		
		Include Openings	<input checked="" type="checkbox"/>		
		Min. Distance between Joists	300		
		Add Details if Element is Crossing Joist	<input type="checkbox"/>		
		Add Details if Joist is Crossing Element	<input checked="" type="checkbox"/>		
		Add Details for L Connections	<input checked="" type="checkbox"/>		
		Add Details if Studs are Nested	<input type="checkbox"/>		

**Min. Distance between Joists** – define the minimum distance between joists where details will be inserted.

*Example: In the case below, a detail was not placed between studs that were very close to each other.*





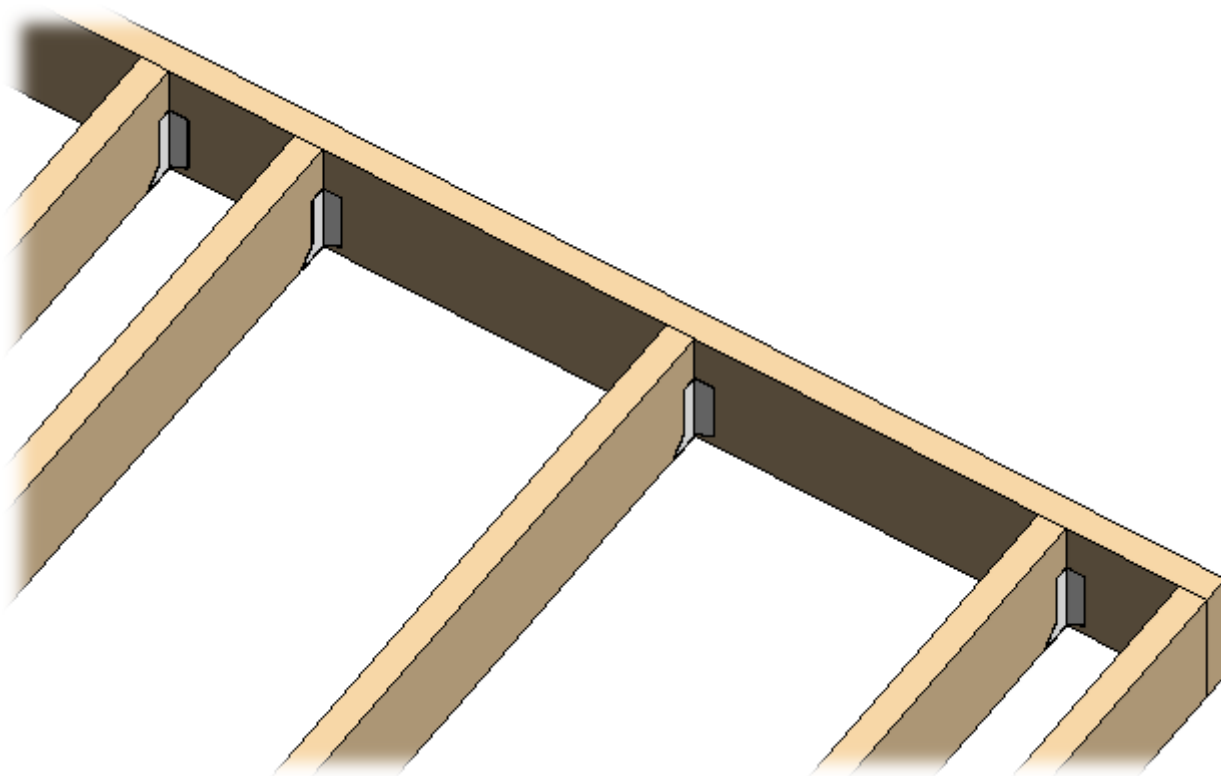

### Add Details if Element is Crossing Joist

Details		Details II	Details III	Details IV
	Details on Bridging/Blocking/Rim Joist			
	Bridging/Blocking/Rim Joist Holes			
	Details on Joist			
	Additional Details			
	Location on Additional Bridging/.../Blocking			Front Face
	Location on Header 2			None
	Location on Header 1			None
	Include Openings			<input checked="" type="checkbox"/>
	Min. Distance between Joists			50
	Add Details if Element is Crossing Joist			<input type="checkbox"/>
	Add Details if Joist is Crossing Element			<input checked="" type="checkbox"/>
	Add Details for L Connections			<input checked="" type="checkbox"/>
	Add Details if Studs are Nested			<input type="checkbox"/>

**Add Details if Element is Crossing Joist** – adds details in places where rim joist/bridging/nogging is crossing joist.





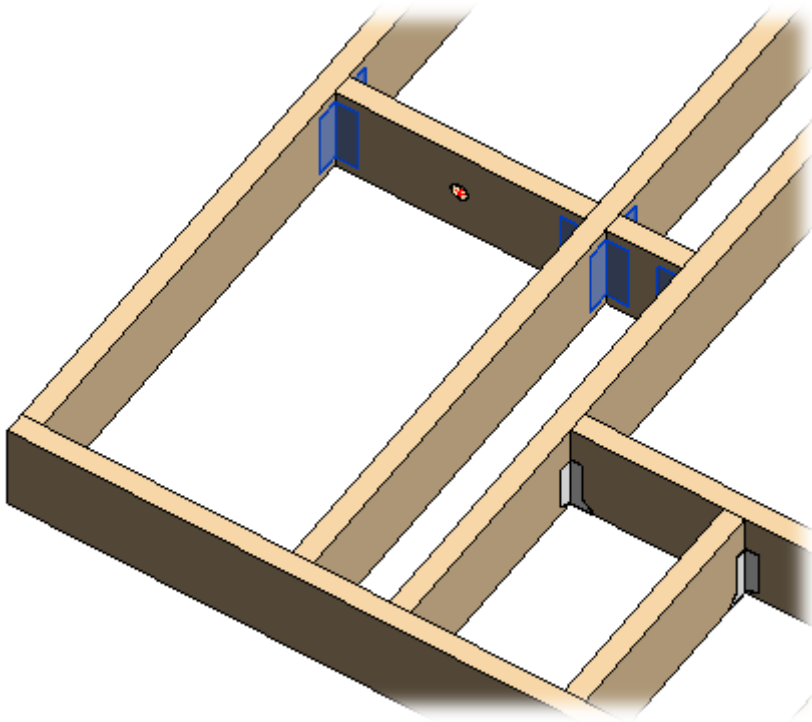

### Add Details if Joist is Crossing Element

Details		Details II	Details III	Details IV
	Details on Bridging/Blocking/Rim Joist			
	Bridging/Blocking/Rim Joist Holes			
	Details on Joist			
	Additional Details			
	Location on Additional Bridging/.../Blocking			Front Face
	Location on Header 2			None
	Location on Header 1			None
	Include Openings			<input checked="" type="checkbox"/>
	Min. Distance between Joists			50
	Add Details if Element is Crossing Joist			<input type="checkbox"/>
	Add Details if Joist is Crossing Element			<input checked="" type="checkbox"/>
	Add Details for L Connections			<input checked="" type="checkbox"/>
	Add Details if Studs are Nested			<input type="checkbox"/>

**Add Details if Joist is Crossing Element** – adds details in places where joist is crossing rim joist/bridging/nogging.



## Add Details for L Connections

 Details on Bridging/Blocking/Rim Joist	Details	Details II	Details III	Details IV
 Bridging/Blocking/Rim Joist Holes	Location on Additional Bridging/.../Blocking	Front Face		
 Details on Joist	Location on Header 2	None		
 Additional Details	Location on Header 1	None		
	Include Openings	<input checked="" type="checkbox"/>		
	Min. Distance between Joists	50		
	Add Details if Element is Crossing Joist	<input type="checkbox"/>		
	Add Details if Joist is Crossing Element	<input checked="" type="checkbox"/>		
	Add Details for L Connections	<input checked="" type="checkbox"/>		
	Add Details if Studs are Nested	<input type="checkbox"/>		

**Add Details for L Connections** – adds details near L roof connections.

## Additional Details

Details on Bridging/Blocking/Rim Joist

Bridging/Blocking/Rim Joist Holes

Details on Joist

Additional Details

Additional Details		Additional Details II		Additional Details III		Additional Details IV		Additional Details V		Additional Details VI	
Joist											
Element											Insert Details
End Connection Joist											<input checked="" type="checkbox"/>
Common Joist											<input type="checkbox"/>
Trimming Joist											<input type="checkbox"/>
Trimmer											<input type="checkbox"/>
Top Trimmer											<input type="checkbox"/>
Bottom Trimmer											<input type="checkbox"/>
Top Cripple											<input type="checkbox"/>
Bottom Cripple											<input type="checkbox"/>
Edge Joist											<input type="checkbox"/>

Rim-Joist	
Element	Insert Details
Rim Joist 2	<input type="checkbox"/>
Rim Joist 1	<input type="checkbox"/>
Top Cover Type	<input type="checkbox"/>
Bottom Pad Type	<input type="checkbox"/>
B/N/B	<input type="checkbox"/>
Top Plate Support	<input type="checkbox"/>
Header 2	<input type="checkbox"/>
Header 1	<input type="checkbox"/>

Type	M_SC_Anchor : D16
Width (b)	12.7
Depth (h,d)	12.7
Define Depth (h,d) by Layer Thickness	<input type="checkbox"/>
Distance/Spacing	400
Total Amount	5
Origin Point	Start Point
Offset	200
Location on Joist	Right Face

**Additional Details** – features for adding additional details by predefined rules.

*Example: Anchors are added into end connection joists with predefined spacing:*

