

SHOP DRAWINGS – Part Assembly Menu

Modified on: Sat, 14 Sep, 2019 at 10:42 AM

Part Assembly Menu

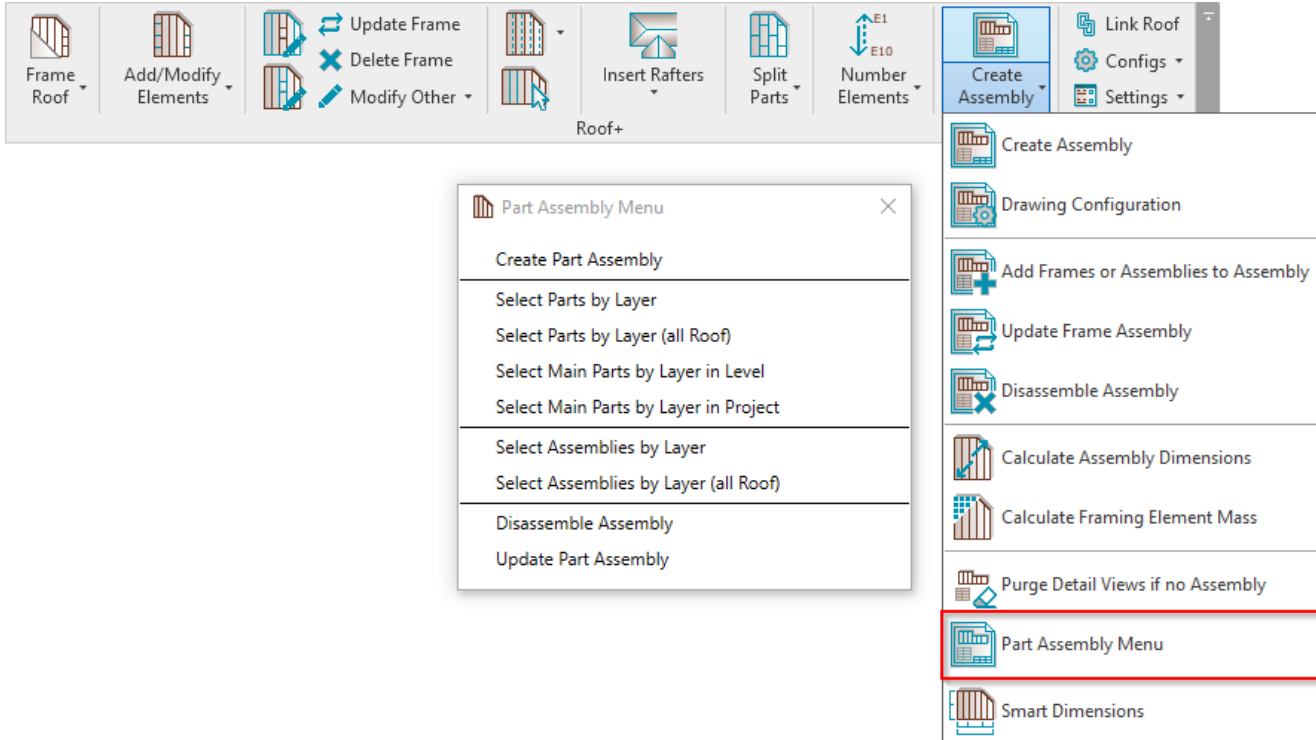

Part Assembly Menu – features for creating a part assembly and different part selection options.

Create Part Assembly

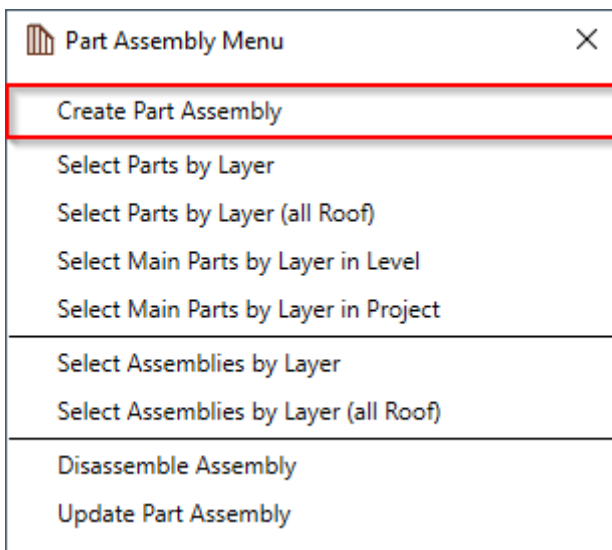

Create Part Assembly – makes shop drawings for selected framed parts. Select any frame of the roof and click Create Part Assembly. The software will create shop drawings according to predefined configurations. You can find shop drawings in Project Browser under Assemblies.

*Mandatory condition: selected part needs to have **Mark** value assigned:*

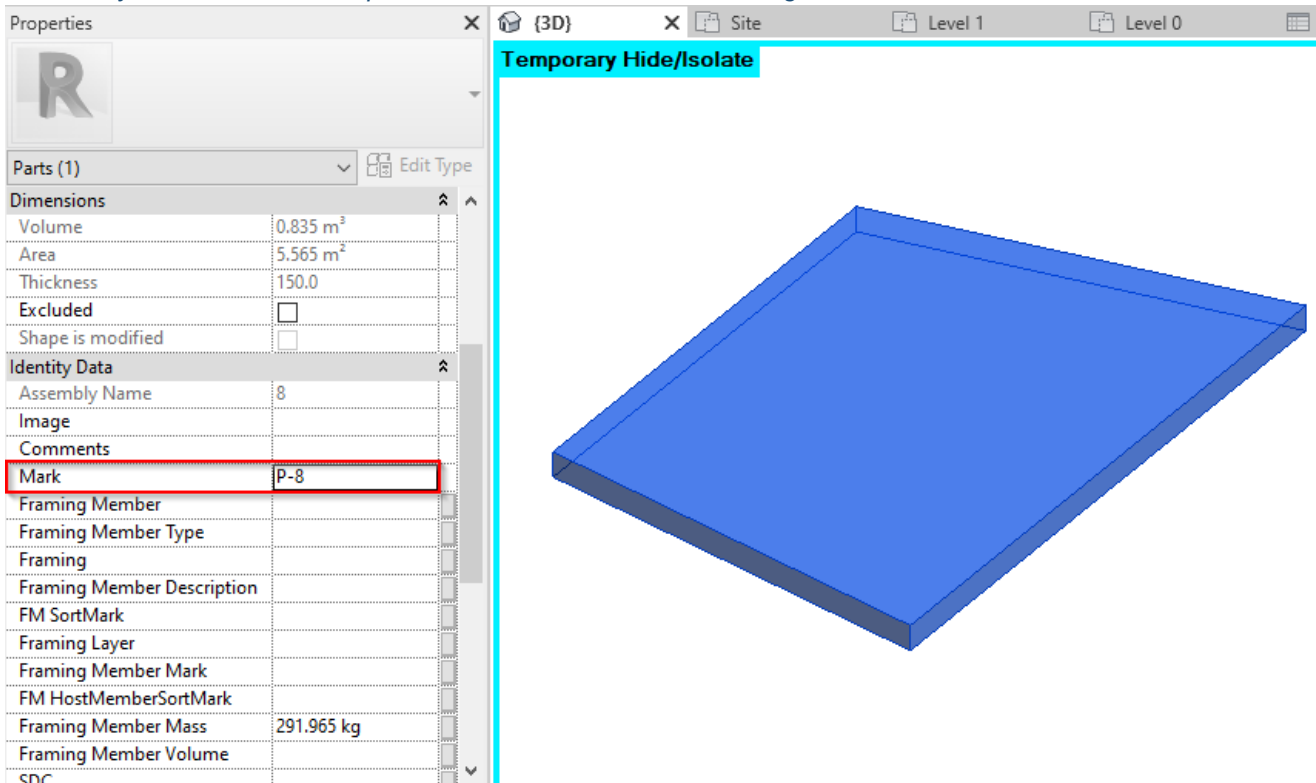

*This value will be used as the assembly name. You can find shop drawings in **Project Browser** under **Assemblies**. An assembly combines all parts in a single entity, which is scheduled and isolated to create shop drawing views with tags and dimensions.*

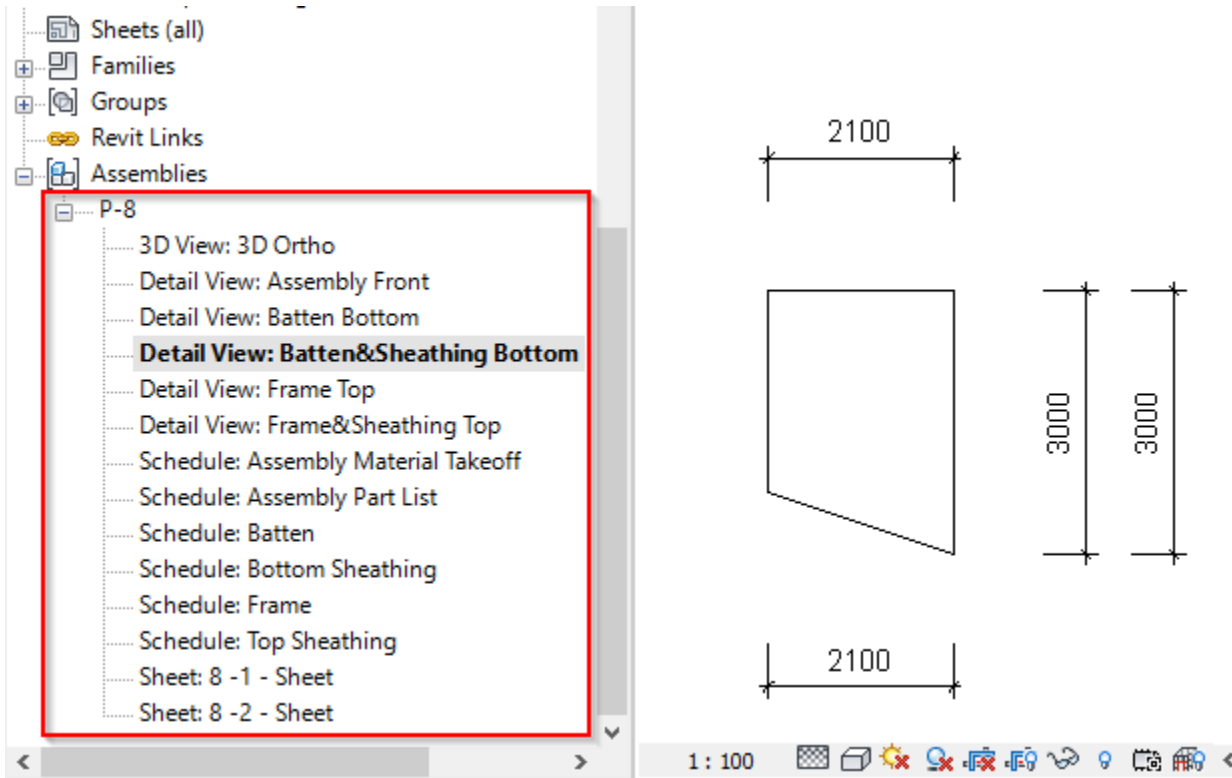

Select Parts by Layer

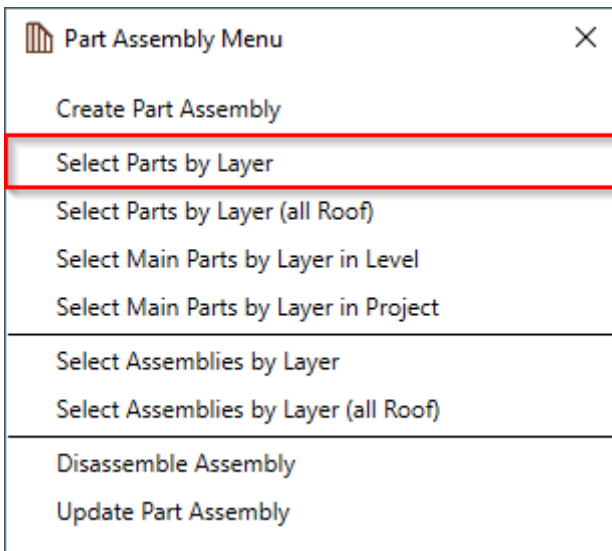

Select Parts by Layer – selects main parts in the framed roof.

Please make sure **Show Parts** or **Show Both** is selected in **View Properties** → **Parts Visibility**:

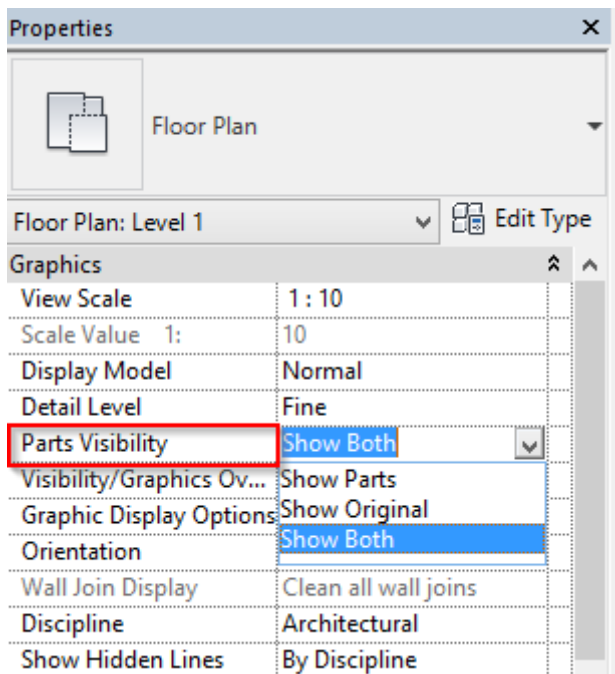

*Example: Click **Select Parts by Layer** and you will be able to select only main parts from the framed roof:*

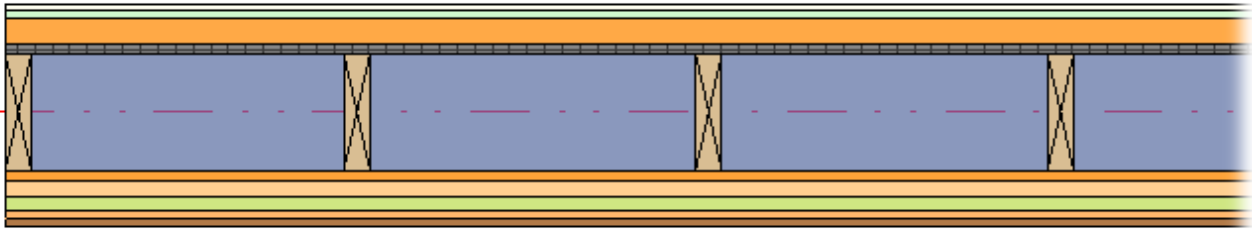
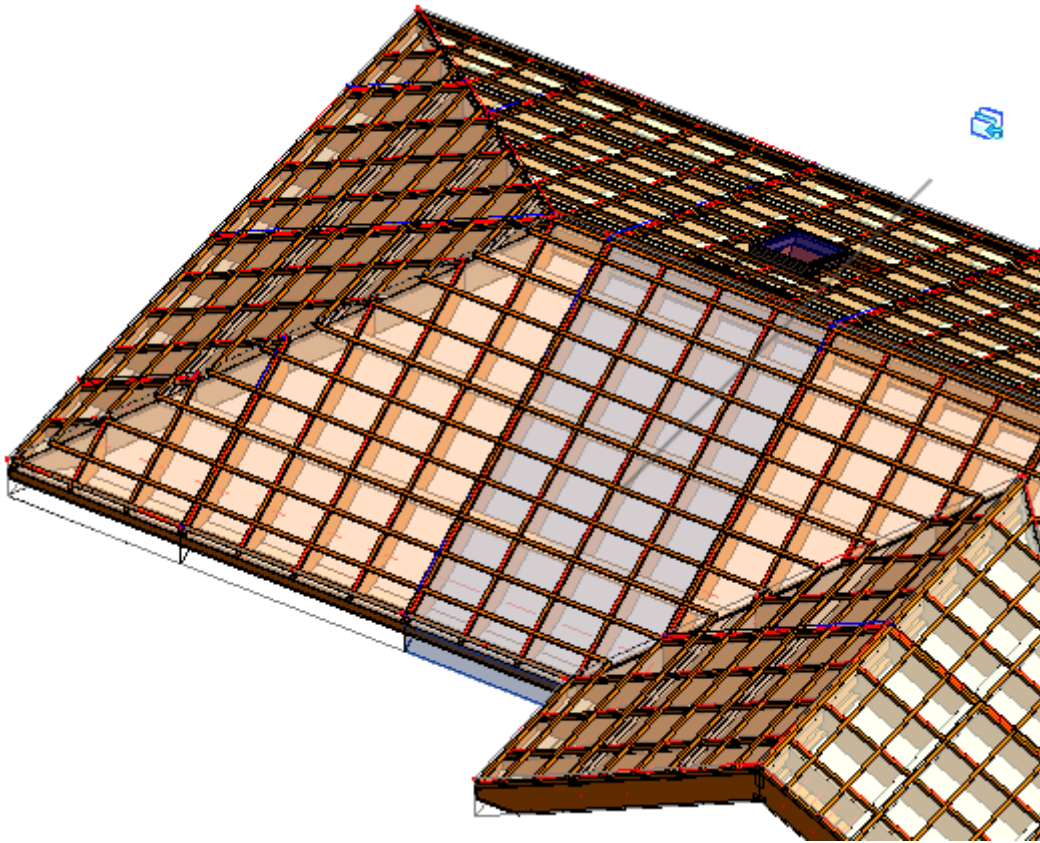

Select Parts by Layer (all Roof)

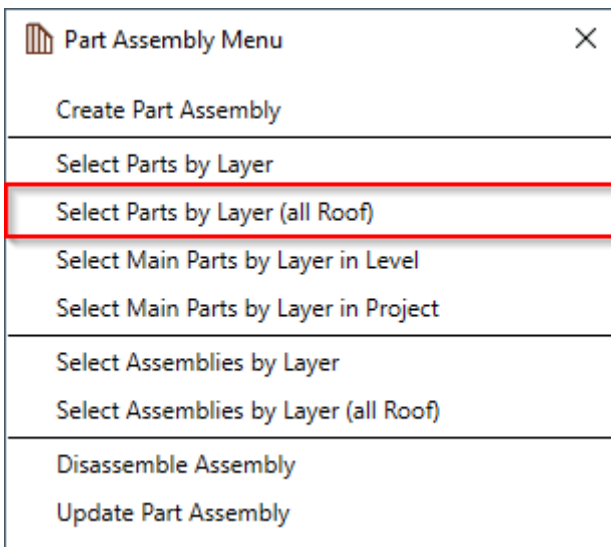

Select Parts by Layer (all Roof) – selects all framed parts in the roof.

Make sure **Show Parts** or **Show Both** is selected in **View Properties** → **Parts Visibility**:

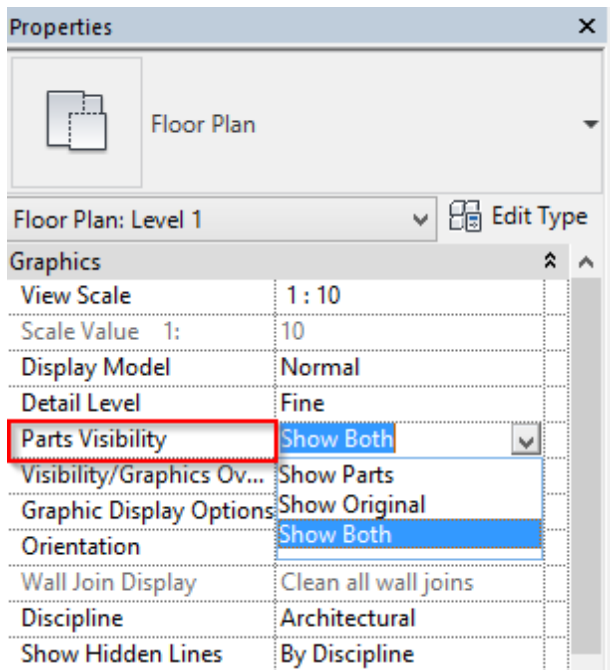

*Example: Click **Select Parts by Layer (all Roof)** and you will able to select all framed parts from the roof:*

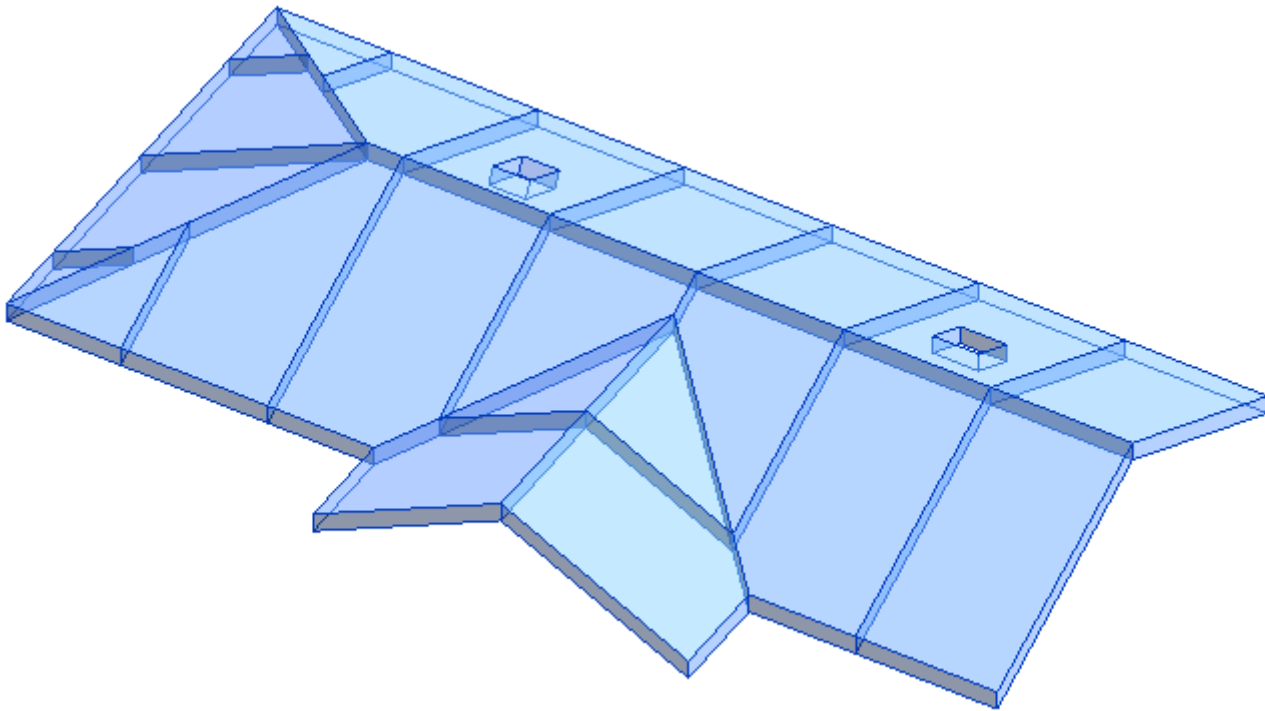

Select Main Parts by Layer in Level

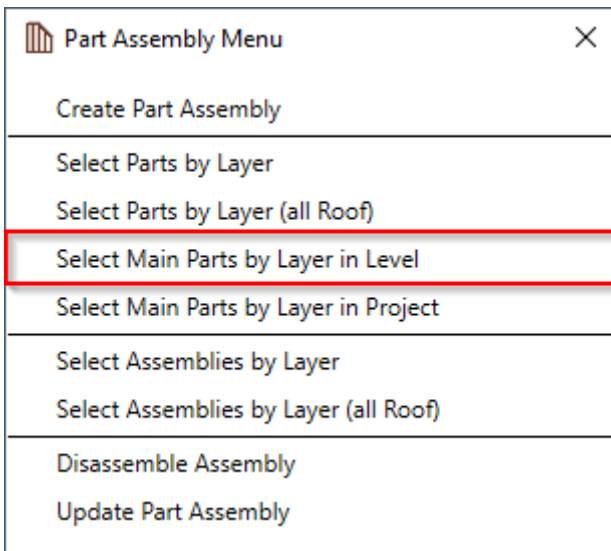

Select Main Parts by Layer in Level – selects main parts in roof frames of the same type in the same level.

Make sure **Show Parts** or **Show Both** is selected in **View Properties** → **Parts Visibility**:

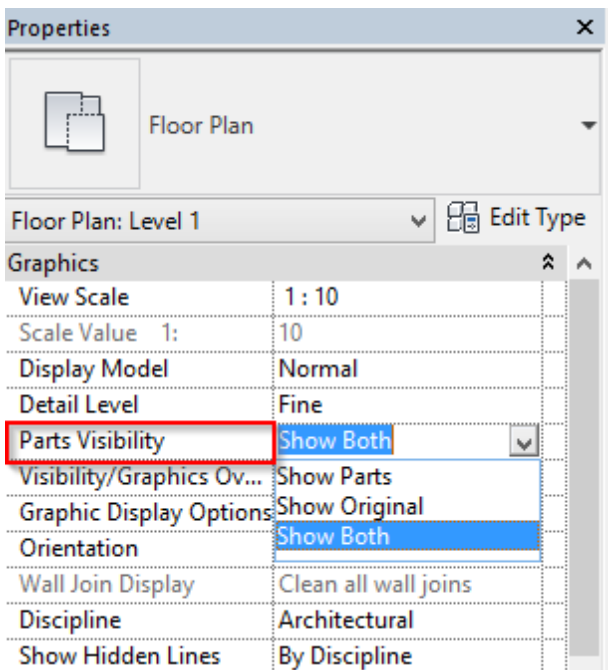

*Example: Click **Select Main Parts by Layer in Level** → Select one main part in the framed roof → All main parts of the same type in the same level will be selected:*

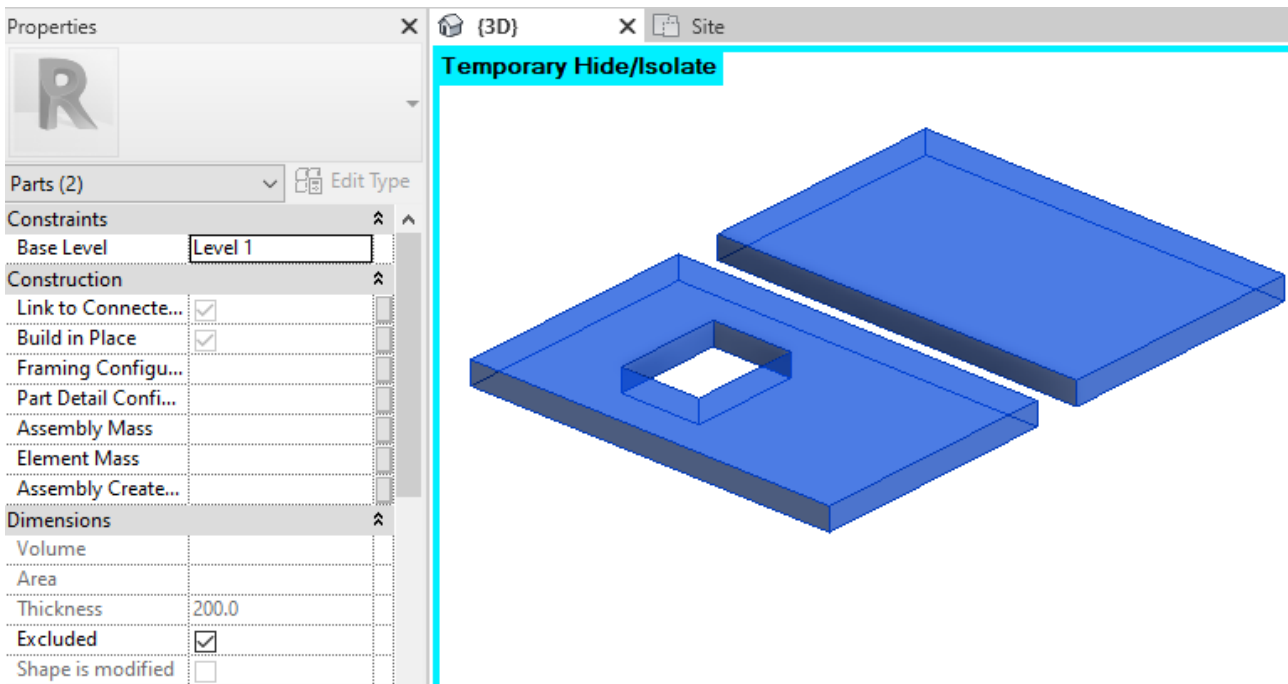

Select Main Parts by Layer in Project

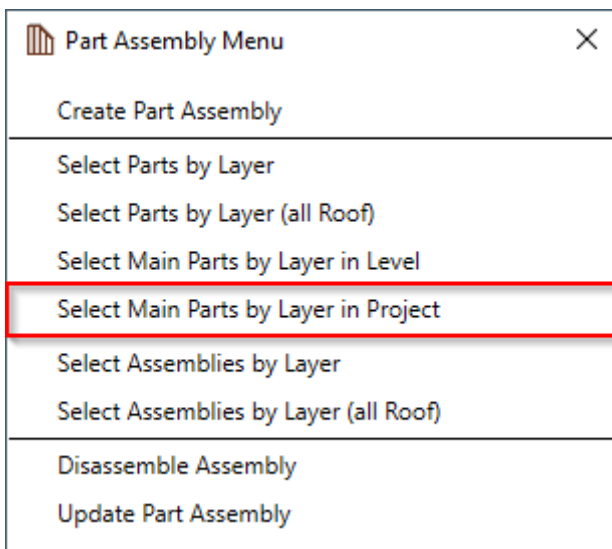

Select Main Parts by Layer in Project – selects main parts in roof frames of the same type in the whole project.

Make sure **Show Parts** or **Show Both** is selected in **View Properties** → **Parts Visibility**:

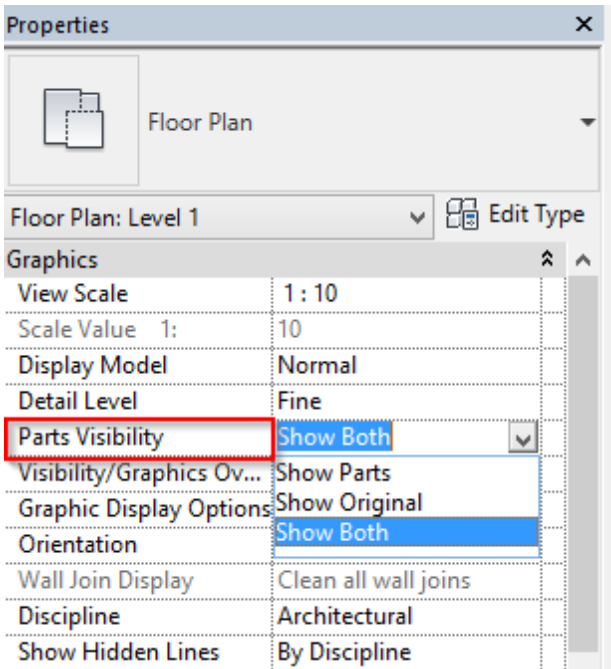

Example: Click **Select Main Parts by Layer in Project** → select one main part in the framed roof → all main parts of the same type in the whole project will be selected. In the image below, the main parts of the external roofs are selected from all levels:

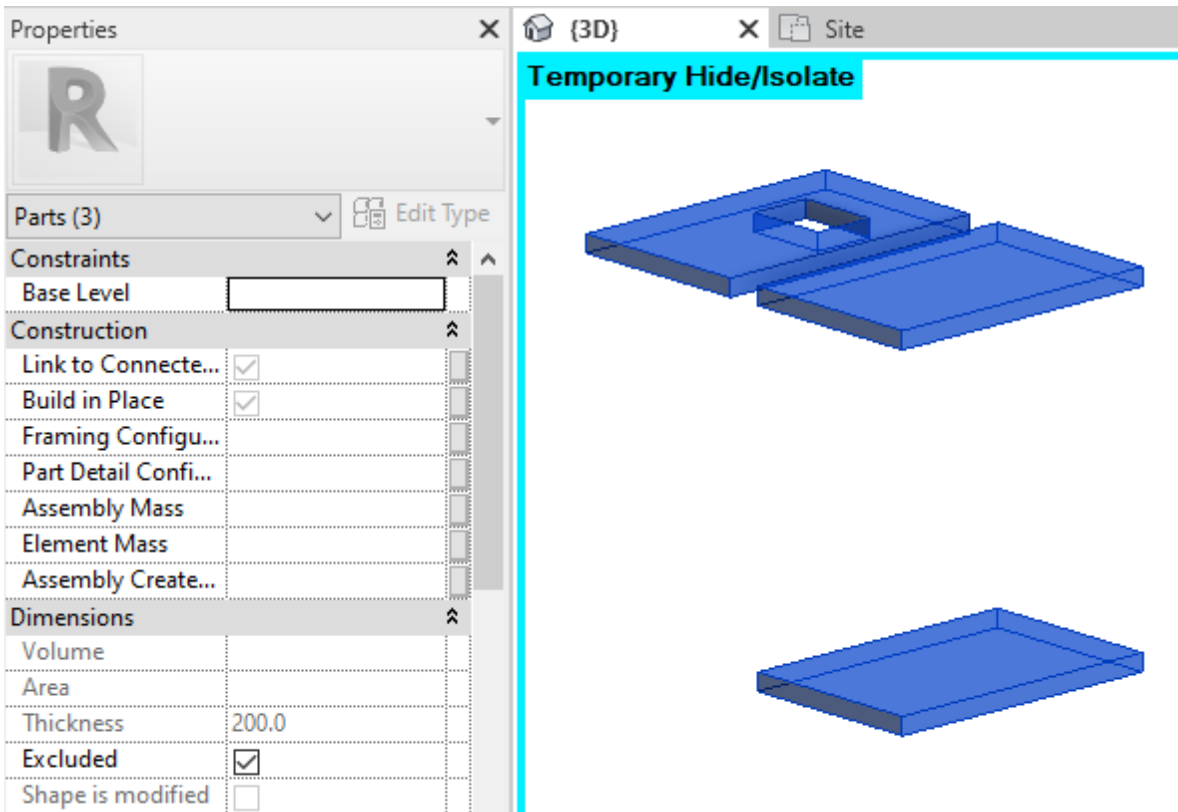

Select Assemblies by Layer

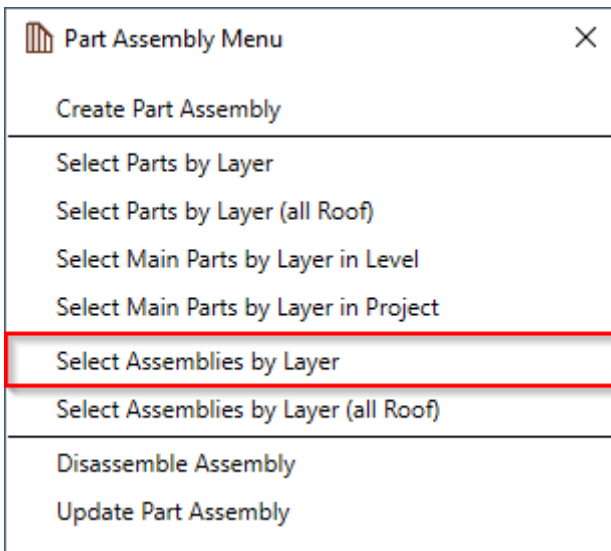

Select Assemblies by Layer – selects all part assemblies from the same roof. You just need to select one assembly and the others will automatically be selected.

Select Assemblies by Layer (all Roof)

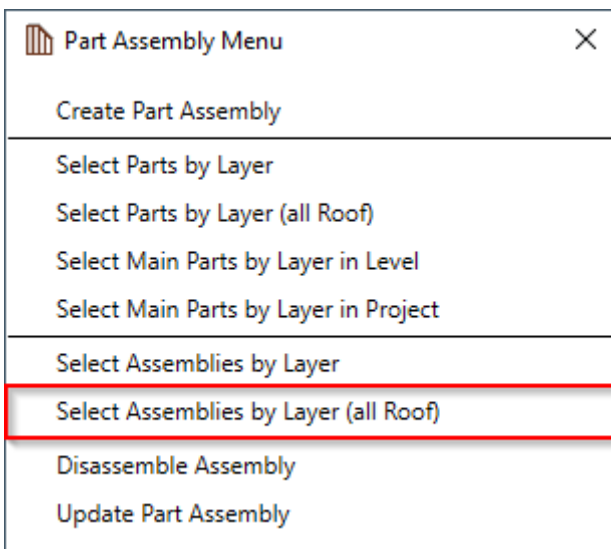

Select Assemblies by Layer (all Roof) – selects all part assemblies from the same roof. You just need to select one assembly and the others will automatically be selected.

Disassemble Assembly

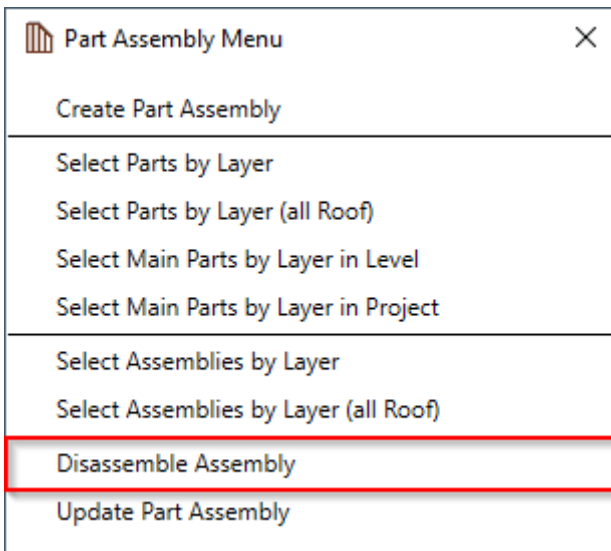

Disassemble Assembly – removes the assembly relationship between elements in the selected assembly and all associated views.

Recommended workflow: Instead of **Revit** → **Disassemble**, we recommend using **Roof+** → **Part Assembly Menu** → **Disassemble Assembly** as it doesn't show unnecessary pop-ups and deletes the gravity point.

Update Part Assembly

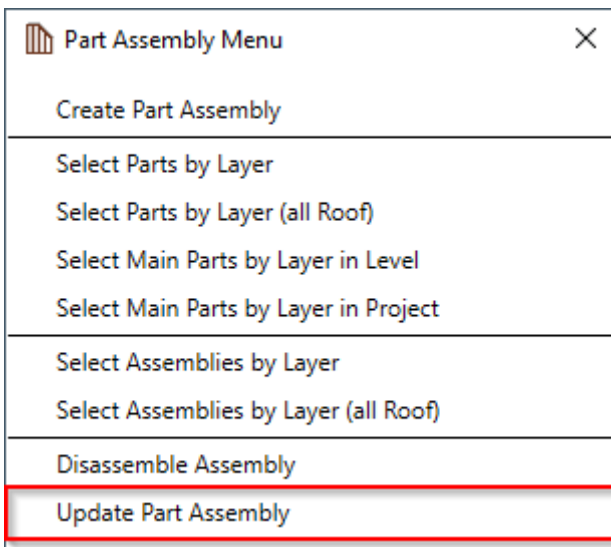

Update Part Assembly – updates the selected part assembly if any changes were made to the parts or to the **Drawing Configuration**.