

**IDEA StatiCa s.r.o.**

# **IDEA Detail**

## **Discontinuity regions design**

Version 9.0

## CONTENTS

<b>1 Introduction</b> .....	<b>4</b>
1.1 Program requirements .....	4
1.2 Installation guidelines .....	4
<b>2 User interface</b> .....	<b>5</b>
2.1 Main window view .....	5
2.1.1 Manipulating 3D view .....	6
2.1.2 Manipulating 2D view .....	8
2.2 Table editor .....	9
<b>3 Units setting</b> .....	<b>11</b>
<b>4 Pictures gallery</b> .....	<b>12</b>
4.1 Pictures manager .....	12
<b>5 Working with project</b> .....	<b>14</b>
5.1 New project .....	15
<b>6 Input and check of discontinuity region</b> .....	<b>16</b>
6.1 Geometry of discontinuity region .....	17
6.2 Sub-regions .....	20
6.2.1 Member 1D .....	20
6.2.2 Dapped end .....	22
6.2.3 Wall .....	24
6.2.4 Opening .....	26
6.3 Supports .....	28
6.3.1 Point distributed support .....	28
6.3.2 Point bearing plate .....	30
6.3.3 Line support .....	32
6.3.4 Hanging support .....	34
6.3.5 Patch support .....	36
6.4 Load transfer devices .....	37
6.4.1 Bearing plate .....	37
6.4.2 Hanging load .....	38
6.4.3 Patch load .....	40
6.5 Load effects .....	41
6.5.1 Load cases .....	41
6.5.2 Internal forces in sections or supports .....	42
6.5.3 Load impulses .....	43
6.5.4 Ribbon group Loads .....	48
6.5.5 Ribbon group Internal forces .....	48
6.6 Reinforcement .....	50
6.6.1 Design of reinforcement distribution .....	50
6.6.2 Group of reinforcement bars .....	53
6.6.3 Bent-up bar .....	59
6.6.4 Inclined reinforcement bar .....	61
6.6.5 Cage around the opening .....	63
6.6.6 Group of stirrups .....	65
6.6.7 Cage around patch support/load .....	67
6.6.8 Hanging around patch support/load .....	69
6.6.9 Wire fabrics .....	71
6.6.10 Longitudinal bar anchorage types .....	73
<b>7 User defined templates</b> .....	<b>74</b>
7.1 Creating a discontinuity region from the user template .....	75
7.2 Reinforcing a discontinuity region from the user template .....	76
7.3 Templates manager .....	76
<b>8 Check of discontinuity region</b> .....	<b>78</b>
8.1 Selecting the evaluated load case .....	79
8.2 Summary check results .....	80

8.2.1 Drawing settings .....	80
8.3 Strength check evaluation .....	82
8.3.1 Concrete strength check .....	83
8.3.2 Reinforcement strength check .....	85
8.4 Reinforcement anchorage check .....	87
8.4.1 Drawing settings .....	88
8.5 Stress limitation check evaluation .....	89
8.5.1 Concrete stress limitation check .....	90
8.5.2 Reinforcement stress limitation check .....	92
8.6 Crack width check .....	94
8.6.1 Ribbon group Crack width .....	95
8.6.2 Ribbon group Model .....	95
8.6.3 Drawing settings .....	96
8.7 Deflection calculation .....	97
8.7.1 Drawing settings .....	99
8.8 Auxiliary results .....	100
8.8.1 Tensile strain evaluation .....	100
8.8.2 Evaluation of deformations .....	100
8.9 Bill of material .....	102
8.10 Code and calculation settings .....	103
<b>9 Project summary .....</b>	<b>105</b>
9.1 Discontinuity regions in project .....	105
9.1.1 Project data .....	106
9.1.2 Adding discontinuity region into the project .....	106
9.1.3 Ribbon group New discontinuity region .....	106
9.2 Preview and print of calculation report .....	108
9.2.1 Ribbon group Items in report .....	108
9.2.2 Ribbon group Type of report .....	108
9.2.3 Brief report .....	108
9.2.4 Detailed report .....	110
9.2.5 Ribbon group Report view .....	113
9.3 Cross-sections .....	114
9.4 Materials .....	116
9.5 Settings .....	117

# 1 Introduction

## 1.1 Program requirements

Application requires .NET Framework 4.7 to be installed on the computer. It can be downloaded from web pages of Microsoft Company (<https://www.microsoft.com/en-us/download/details.aspx?id=56115&desc=dotnet47>).

In case of a missing .NET Framework the installation is not launched.

## 1.2 Installation guidelines

IDEA Detail program is installed as a part of IDEA StatiCa package.

## 2 User interface

The items of the user interface of the application are grouped into following groups:

- **Navigator** – it contains main commands for the work with a project.
- **Ribbons** – contain sets of controls. Ribbons content changes according to the current Navigator command.
- **Main window** – it is used mainly for appropriate drawings.
- **Data window** – properties of objects and results of analysis are displayed in this window according to current Navigator command

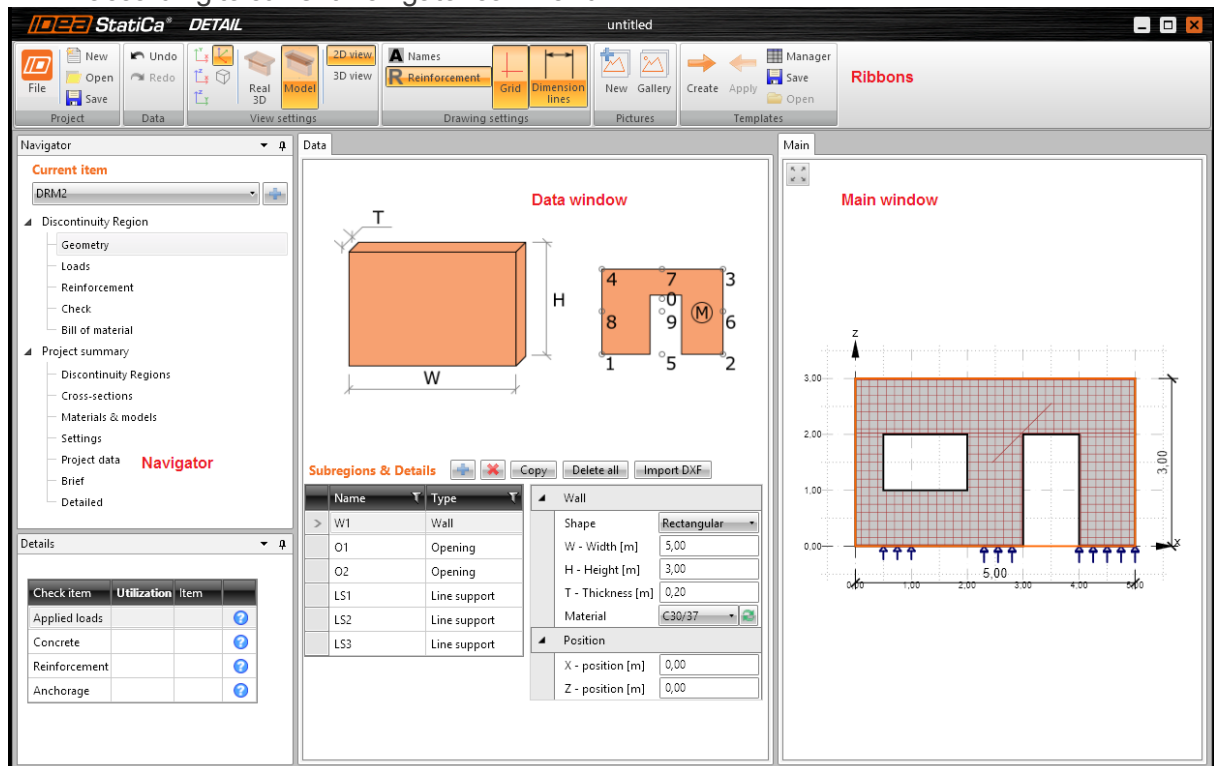



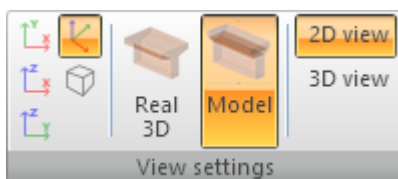

### 2.1 Main window view

2D or 3D calculation model of current discontinuity region or real 3D structure is drawn in the Main window.



Commands in ribbon group **View settings** to set the view:

-  – switch to the top view (opposite the direction of positive Z-semi-axis of the global coordinate system).
-  – switch to the side view (opposite the direction of positive Y-semi-axis of the global coordinate system).

-  – switch to the front view (opposite the direction of positive X-semi-axis of the global coordinate system).
-  – switch to the default 3D view and zooms the structure to fit into the main window.
-  – switch on/off the perspective view mode.
- **Real 3D** – switch to draw a real structural shape in 3D.
- **Model** – switch to draw analysis model of the structure.
- **2D view** – switch to draw a 2D view of the calculation model.
- **3D view** – switch to draw a 3D view of the calculation model.

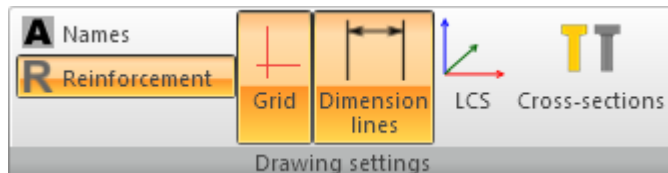

Drawing options can be set in ribbon group **Drawing settings**:

- **Names** – switch on/off drawing of names of discontinuity region items.
- **Reinforcement** – switch on/off drawing of defined reinforcement.
- **Grid** – switch on/off drawing of a grid in 2D model drawings.
- **Dimension lines** – switch on/off drawing of dimension lines of discontinuity region items.
- **LCS** – switch on/off drawing of the local coordinate system of individual subregions.
- **Cross-sections** – switch on/off drawing of cross-sections and models of cross-sections of the current subregion.

### 2.1.1 Manipulating 3D view

To set the required view point in 3D window use commands in right top corner of 3D window or keyboard shortcuts with mouse keys. Also the **View cube** tool in the right top corner of Main window can be used to set the 3D view.

Commands in 3D window:



- home view. Click this button to set the default 3D view.



- magnifying glass. Click this button to increase the area under mouse pointer.



- zoom window. Click this button and drag mouse with holding left mouse button to draw window to zoom.



- increase/decrease view. Click this button and drag mouse with holding left mouse button to increase/decrease the view.



- pan the view. Click this button and drag mouse with holding left mouse button to pan the view.



- rotate the view. Click this button and drag mouse with holding left mouse button to rotate the view.



- zoom all. Click this button to fit the whole structure to the 3D window.

To set the required view using keyboard and mouse following combinations can be used:

- click and hold mid mouse button – moving the mouse pans the view.
- push CTRL and hold mid mouse button – moving the mouse rotates the view
- push SHIFT and hold mid mouse button – moving the mouse increases/decreases the view

Right mouse button click into the 3D window displays following context menu:

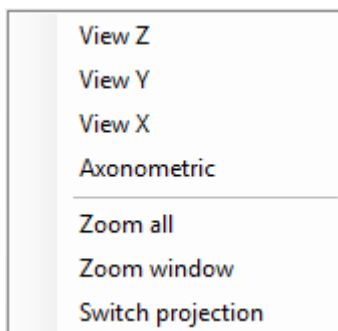

- **View Z** – switch the view opposite the global Z-axis.
- **View Y** – switch the view opposite the global Y-axis.
- **View X** – switch the view opposite the global X-axis.
- **Zoom all** – zoom the view to fit the whole structure.
- **Zoom window** – zoom the defined rectangular area.
- **Switch projection** – switch between the axonometric and perspective view.

## 2.1.2 Manipulating 2D view

The view in 2D window can be set by mouse or by tool in the left upper corner of the window.

-  - zoom all. Click this button to fit the whole structure to the 2D window.

To set the required view using keyboard and mouse following combinations can be used:

- Click and hold mid mouse button – moving the mouse pans the view.
- Roll with mid mouse button – moving the mouse increases / decreases the view.
- Push CTRL+SHIFT and hold mid mouse button – moving the mouse defines the window for zoom.

Click right mouse button over 2D window shows context menu with following commands:

- **Zoom all** – zoom to show the whole current structure in the 2D window.
- **Print** – start printing of the current content of 2D window on selected printer.
- **To bitmap** – start export of the current content of 2D window to the raster graphics file (PNG, GIF, BMP, JPEG, TIFF).
- **To clipboard** – copy of the current content of 2D window to the Windows clipboard.
- **To DXF** – start export of the current content of 2D window to the 2D DXF file.

### 2.1.2.1 DXF export settings

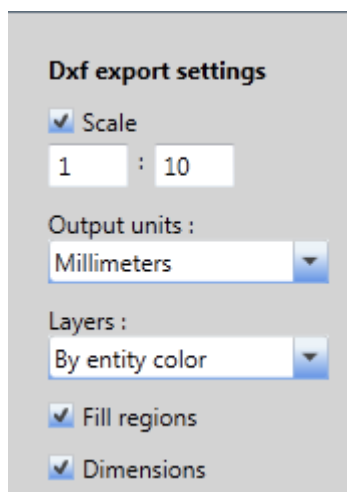

Following export parameters can be set in the Save as dialog when exporting the view to the 2D file:

- **Scale** – if the option is selected, the scale ratio used to create the drawing in exported DXF can be set.
- **Output units** – select units of the drawing in the exported DXF file.
- **Layers** – select the mode of layers generation. Layers can be generated according to the line type, the line thickness, the entity type or the entity color.
- **Fill regions** – switch on/off export of filled regions (otherwise only outlines are exported).
- **Dimensions** – switch on/off export of dimension lines.



## 2.2 Table editor

Some input data (vertices of general cross-sections, values of internal forces etc.) can be entered using table editor.

Copy to clipboard and paste from clipboard can be used to enter the value to a single cell or to fill the range of cells (using shortcuts CTRL C (CTRL INS) and CTRL V (SHIFT INS)).

	Y [mm]	Z [mm]
1	-750	537
2	-750	357
3	-110	297
4	-110	-713
5	-225	-743
6	-225	-963
7	225	-963
8	225	-743
9	110	-713
10	110	297
11	750	357
12	750	537
*		

Cells (ranges) can be pasted to the table from the Microsoft Excel table.

When pasting the data to the table the data are inserted to the current position in the table.

If the number of columns in the clipboard is greater than the number of columns in the target table, the redundant columns are ignored.

If the number of rows in the clipboard is greater than one, the rows following the current row in the target table are overwritten. If the number of inserted rows is greater than the number of rows in the target table, the required number of new rows is inserted into the target table.

If a range is selected in the target table and the clipboard contains the only value of one cell, all cells in the selected range are filled with the same value when pasting from the clipboard.

To add a new row to the table click cell \* in the indexes column or use the keyboard shortcut CTRL + ENTER (the last row of the table must be set as current row)

Following keyboard shortcuts can be used when working with the table editor:

- **CTRL +** - insert a row before the current row.
- **CTRL ENTER** - append a row to the current row.
- **CTRL -** - delete the current row.
- **CTRL A** - select the whole table
- **CTRL C (CTRL INS)** – copy the selected cells to the clipboard.
- **CTRL V (SHIFT INS)** – paste the clipboard content to the table
- **TAB** – change the current cell by moving forwards through the cells
- **SHIFT TAB** – change the current cell by moving backward through the cells
- **<, >, ^, v** - change the current cell by moving left, right, up, down

- **F2** – switch to edit mode of the cell and place the cursor to the end of the current cell. Move to the other cell to finish the edit mode with preserving the changes or push ESC to discard the changes.
- **ESC** – close the edit mode discarding the changes.

### 3 Units setting

The units used by the application can be set by menu command **File > Units**.

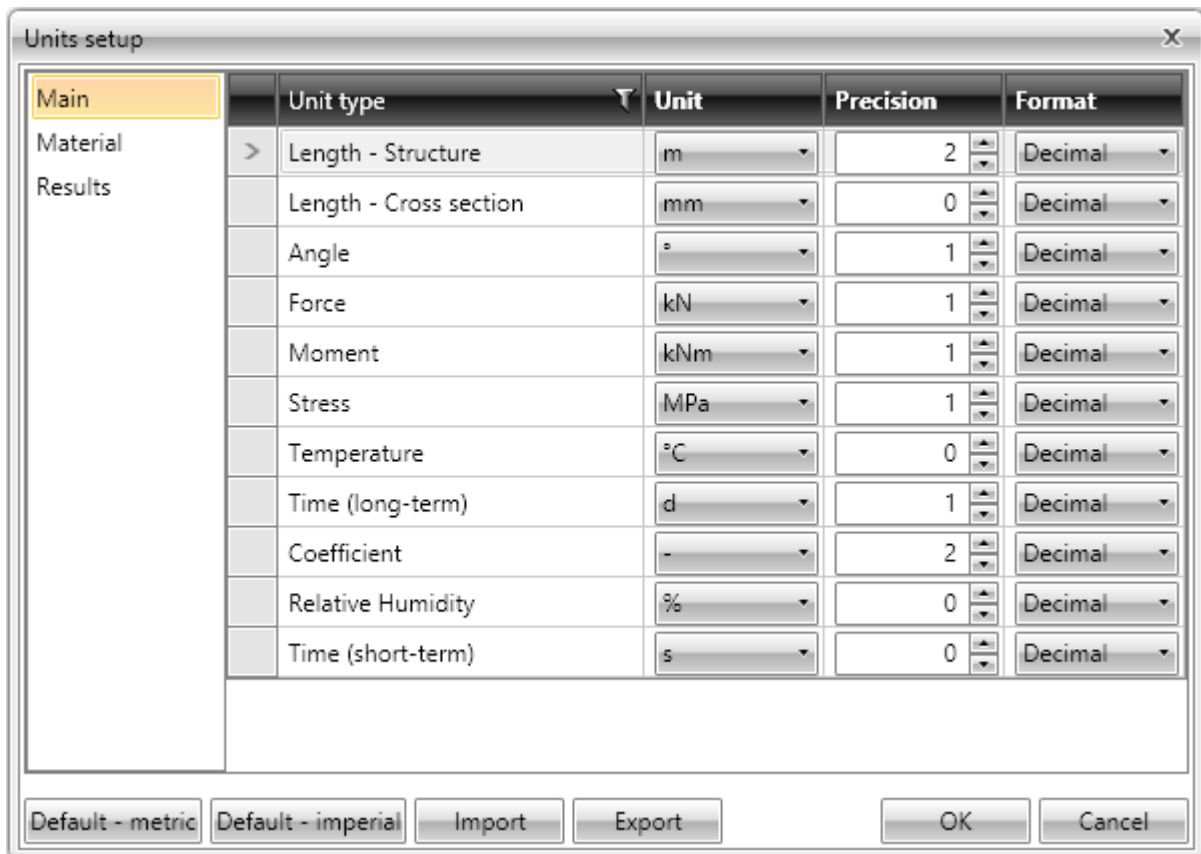

Magnitudes, for which the units can be set, are grouped into categories Main, Material and Results. The categories are displayed in the column on the left of the dialog. For the selected category the table of corresponding magnitudes is displayed. For each magnitude, which is listed in column **Unit type**, one of the available units can be set in the column **Unit**.

For each magnitude the number of digits to be displayed after decimal point can be set in the column **Precision**.

Style of numbers presentation can be set in **Format** column:

- **Decimal** – display numbers in standard decimal format (“ddd.ddd...”).
- **Scientific** – display numbers in exponential format (“d.ddd...E+ddd”).
- **Automatic** – according to length of resulting string it is automatically chosen whether to use decimal or exponential format. In this mode value specified in **Precision** column means number of significant digits in the resulting string.
- **Imperial** – display numbers in fractional format (only for imperial unit types).

**Default – metric** – loads default units settings for metric units system.

**Default – imperial** – loads default units settings for imperial units system.

**Import** - reads the units configuration from a file.

**Export** - saves the current units settings to a file.

Click **OK** to apply the changes and to be used at next application start.

## 4 Pictures gallery

The current drawing in 3D window can be stored into a pictures gallery. The gallery pictures can be printed in the calculation report.

Commands in ribbon group **Pictures** can be used to work with pictures gallery.

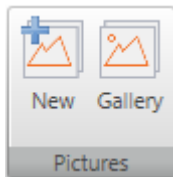

- **New** – add a new picture to the gallery. Dialog **Gallery** appears. The target folder must be selected in the tree control in the left part of dialog. The picture is stored into the selected folder. Name of picture can be modified.
- **Gallery** – start pictures manager.

### 4.1 Pictures manager

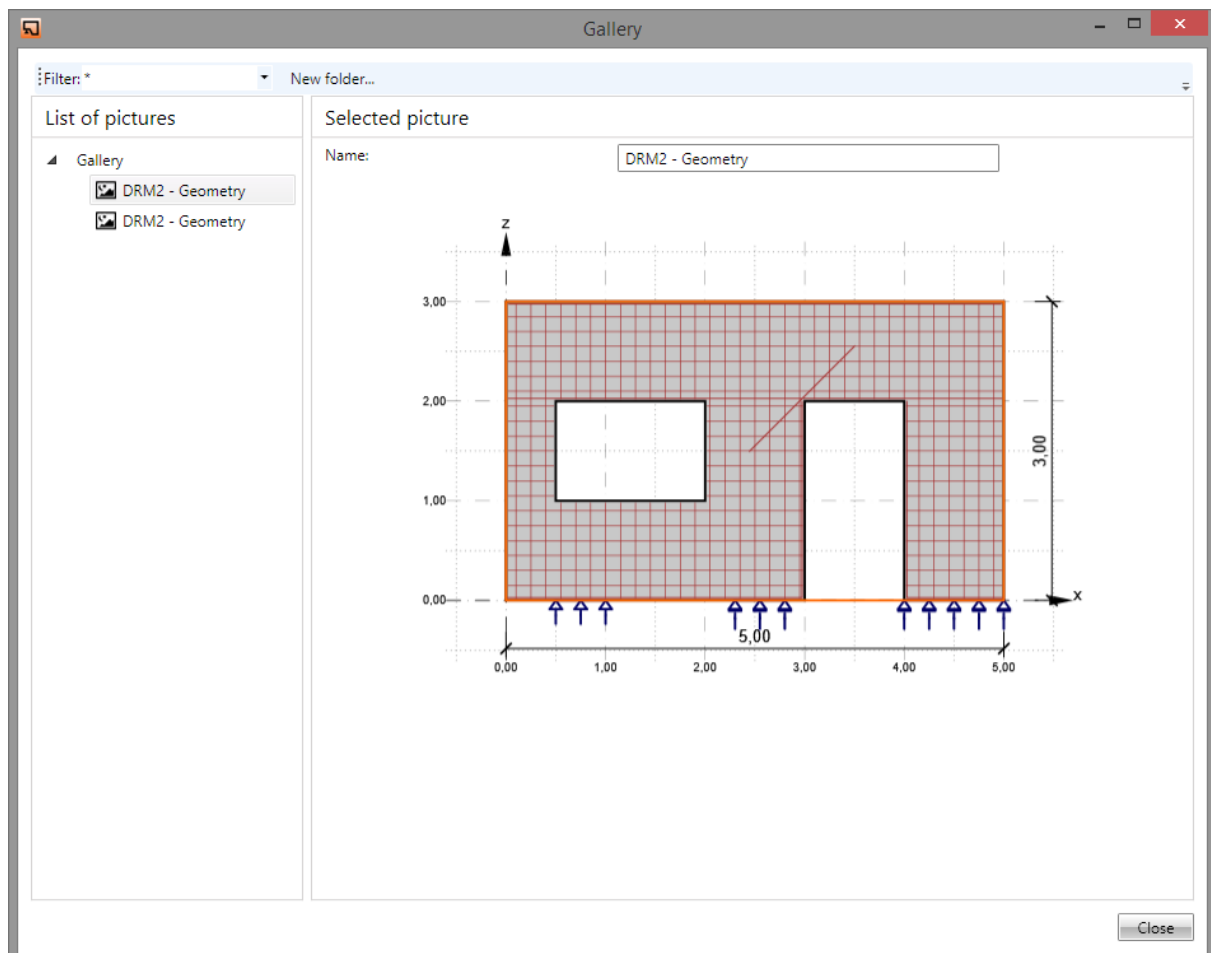

Pictures manager is used to manage pictures in the gallery. The pictures gallery is common for all joints in the current project.

Single joint, for which the pictures are displayed, can be selected in the combo box **Filter**.

The pictures gallery structure (with respect to the filter settings) is displayed in the left part of the dialog. Details of selected picture are displayed in the right part of dialog.

Following actions can be performed in the templates manager:

- **Create new folder** – by command **New folder...** in the main menu to create new folder in the root folder or in the current subfolder.
- **Rename folder** – by command **Edit** in the context menu by right mouse click above the required folder.
- **Move folder** – drag and drop selected folder(s) to the required target folder.
- **Remove folder (s)** – by command **Delete** in the context menu by right mouse click above the selected folder (s). The folder is removed including all subfolders and all pictures in removed folders and subfolders.
- **Edit picture name** – picture name of selected picture is displayed in the right part of the dialog. The picture name can be modified.
- **Move picture** – drag and drop selected picture(s) by mouse to the required target folder.
- **Delete picture(s)** – by command **Delete** in the context menu by right mouse click above the selected picture.

## 5 Working with project

Use commands in ribbon group **Project** to work with project file:

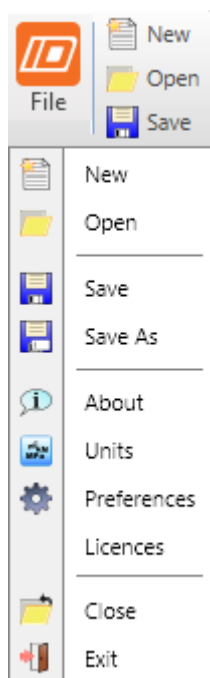



- **New** – create a new project.
- **Open** – open an existing project (files with extension \*.ideaDetail or \*.wsDetail).
- **Save** – save the current project into the data file.
- **Save as** – save the current project into the data file using a new file name.
- **About** – open the About application dialog.
- **Units** – open dialog for units settings - see **Units settings**.
- **Preferences** – open a dialog to set the application language or the logo for printed reports.
- **Licences** – launch **Licence manager** application
- **Close** – close the current project.
- **Exit** – close the application.

## 5.1 New project

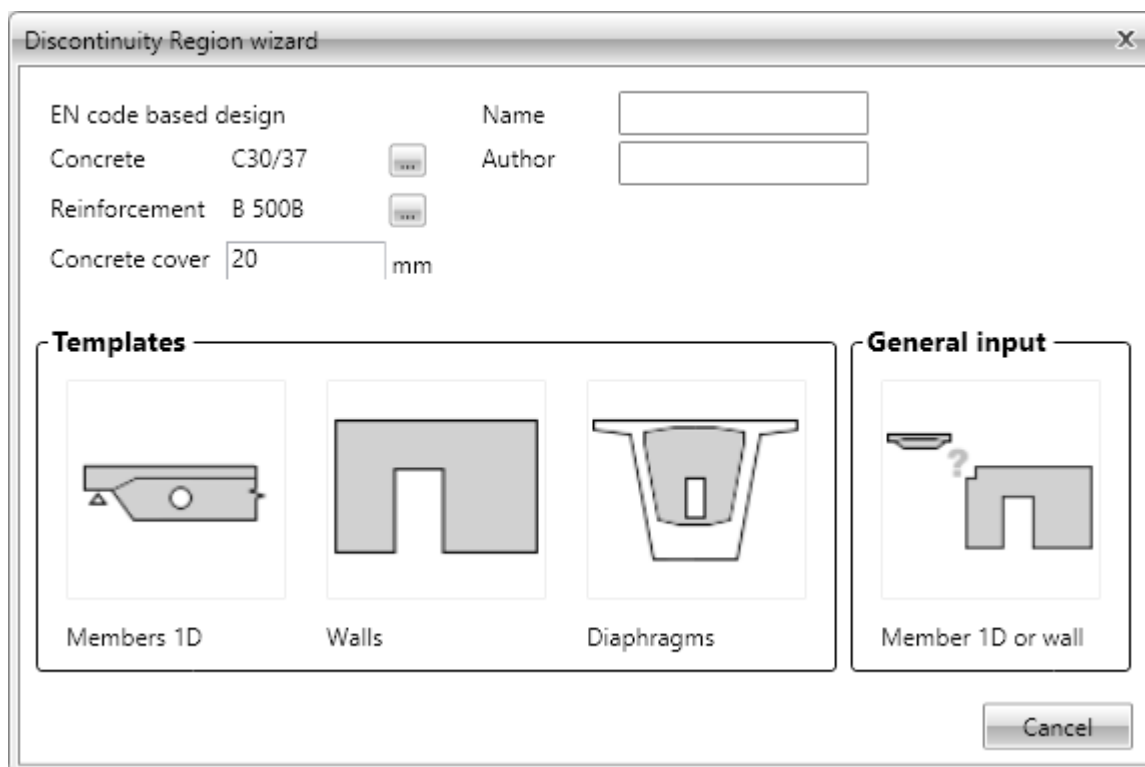
Click **New** in ribbon group **Project** to create a new project. Dialog **Discontinuity region wizard** appears.



Discontinuity region wizard dialog options:

- **Concrete** – select default material of new concrete items of the designed region. The material can be selected from the system database clicking .
- **Reinforcement** – select default material of new reinforcement of designed region. The material can be selected from the system database clicking .
- **Concrete cover** – input default concrete cover value for new project for new project of discontinuity region.
- **Name** – input the region name.
- **Description** – input the region description.
- **Members 1D** – start input of new 1D discontinuity region selection one of the predefined 1D member topologies. Discontinuity region is generated according to the selected topology.
- **Walls** – start input of new wall discontinuity region selection one of the predefined wall member topologies. Discontinuity region is generated according to the selected topology.
- **Diaphragms** – start input of new diaphragm discontinuity region selection one of the predefined diaphragm topologies. Discontinuity region is generated according to the selected topology.
- **Member 1D or wall** – start input of new general discontinuity region. Individual members of the region must be defined manually.

## 6 Input and check of discontinuity region

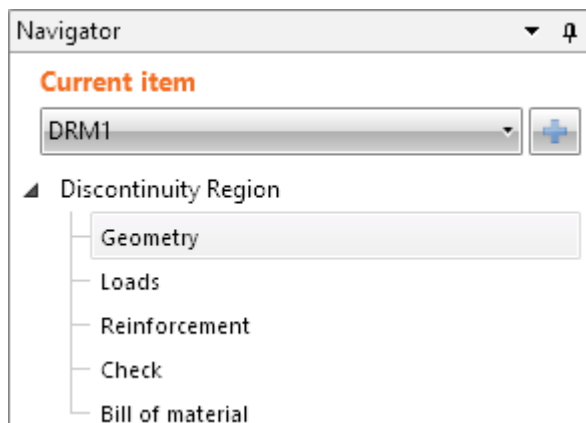

Individual discontinuity region data is defined using corresponding navigator commands.

The discontinuity region is defined by:

- **geometry** – members, sub-regions, and details which are modeling the discontinuity region;
- **loads** – external loads and values of internal forces in supports or sections;
- **reinforcement** – main reinforcement defined by reinforcement bars or wired fabric, stirrups, anchorage types etc.



## 6.1 Geometry of discontinuity region



Click navigator command **Discontinuity region > Geometry** to define the geometry of discontinuity region. Individual sub-regions and details, their cross-sections and positions are defined.

View of the current discontinuity region is drawn in the main window.

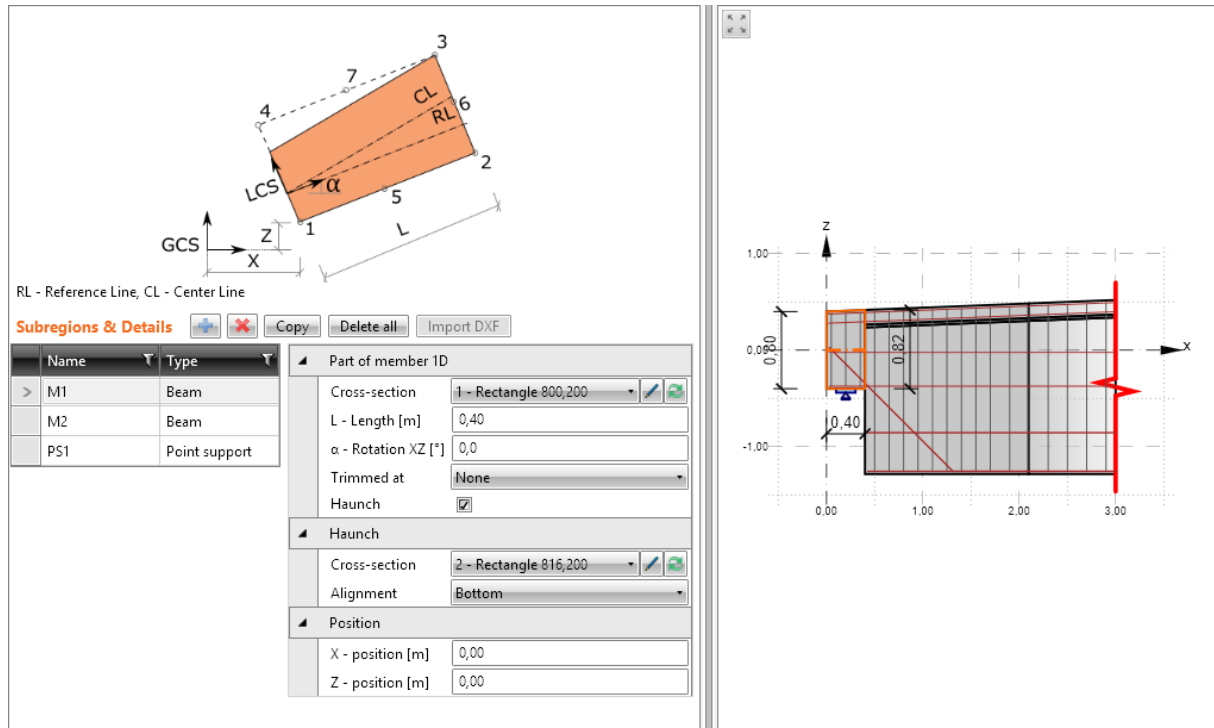
Table of geometry properties of the current sub-region or detail is displayed in the data window.



Commands above the **Sub-regions and details** table:

-  - add a new sub-region or detail into the region.
-  - delete the current sub-region or detail from the region.
- Copy** – create a copy of current sub-region or detail.
- Delete all** – delete all existing sub-regions and details.

Existing sub-regions and details in the current discontinuity region are listed in the table **Sub-regions and details**:

- Name** – input name of sub-region or detail.
- Type** – type of sub-region or detail is printed.

Properties table of the current sub-region or detail is displayed.

Following sub-regions or details can be added into the 1D member discontinuity region:

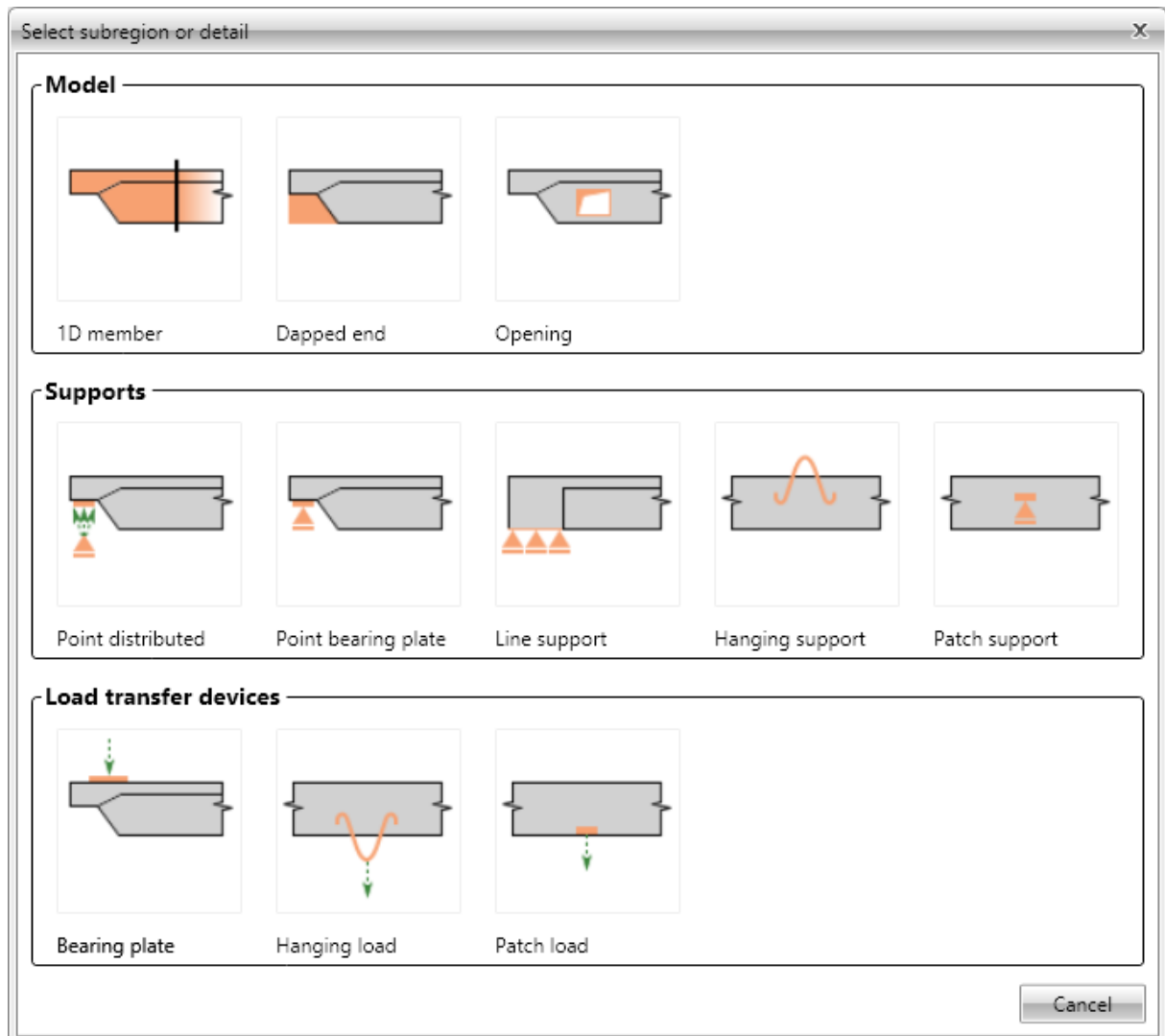

- **1D member**
- **Dapped end**
- **Opening**
- **Point distributed support**
- **Point bearing plate**
- **Line support**
- **Hanging support**
- **Patch support**
- **Bearing plate**
- **Hanging load**
- **Patch load**

Following sub-regions or details can be added into the wall discontinuity region:

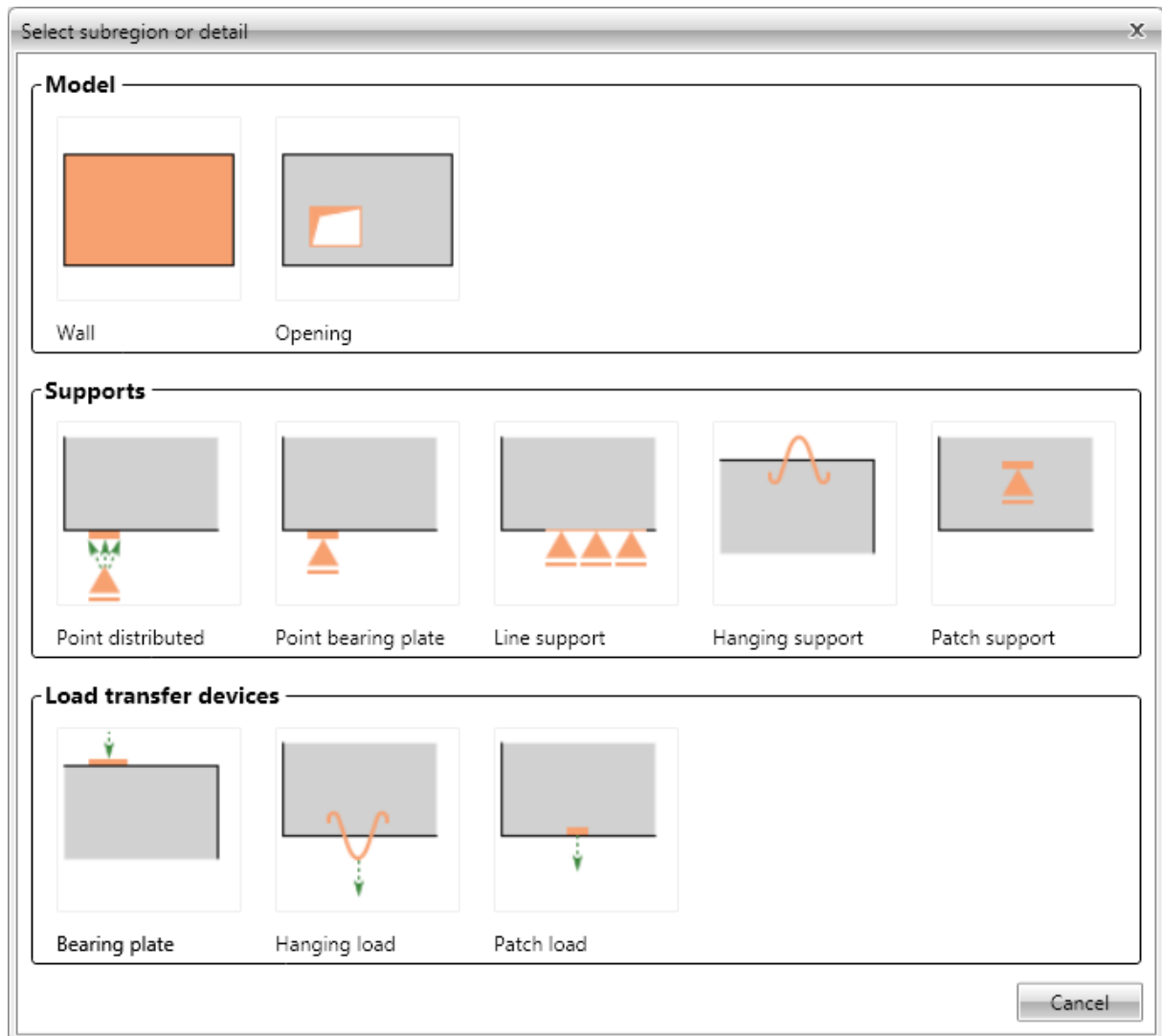

- **Wall**
- **Opening**
- **Point distributed support**
- **Point bearing plate**
- **Line support**
- **Hanging support**
- **Patch support**
- **Bearing plate**
- **Hanging load**
- **Patch load**

## 6.2 Sub-regions

### 6.2.1 Member 1D

Sub-region of **Member 1D** type adds a part of beam defined by length and cross-section into the discontinuity region. Member 1D can contain haunch.

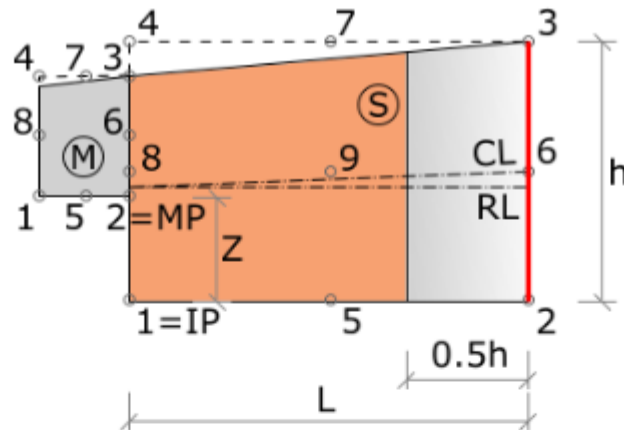

RL - Reference Line, CL - Center Line

#### Subregions & Details



Copy

Delete all

Import DXF

Name	Type
M1	Member 1D
> M2	Member 1D
PS1	Point support

**Part of member 1D**

Cross-section: 3 - T Shape 450,1700

L - Length [m]: 2,60

$\alpha$  - Rotation XZ [°]: 0,0

Trimmed at: End

Haunch:

---

**Haunch**

Cross-section: 4 - T Shape 450,1804

Alignment: Bottom

---

**Position**

M - Master: M1

MP - Master point: 2

IP - Insert point: 1

X - position [m]: 0,00



Z - position [m]: -0,88

Properties group **Part of member 1D**:

- **Cross-section** - select cross-section to be assigned to the member. The cross-section can be selected from the list of all cross-sections available in the project. Click to change cross-section parameters. Click to add a new cross-section and assign it to the appropriate member.

- **L – Length** – input length of the current 1D member part.
- **$\alpha$  – Rotation XZ** – input value of rotation of member 1D part in XZ plane about LCS origin in the centroid of the cross-section at the beginning of the 1D member part or about the insert point for member 1D related to the master part.
- **Trimmed at** – select part of 1D member, on which trimming is applied:
  - **None** – member 1D is not trimmed.
  - **Beginning** – member 1D is trimmed at the beginning.
  - **End** – member 1D is trimmed at the end.
  - **Both** – member 1D is trimmed on both ends.
- **Haunch** – switch on/off application of haunch on part of 1D member.

Properties group **Haunch** – input of cross-section properties at the end of part of 1D member:

- **Cross-section** – select cross-section to be assigned to the end of the part of the 1D member. The cross-section can be selected from the list of all cross-sections available in the project. Click  to change cross-section parameters. Click  to add a new cross-section and assign it to the end of the part of 1D.
- **Alignment** – select alignment of the cross-section along the haunch:
  - **Top** – top edge of the cross-section at the end of member 1D part is aligned to the top edge of the cross-section at the beginning of member 1D part.
  - **Axis** – centers of gravity of cross-sections at the beginning and at the end of member 1D part are placed to the axis of member 1D part.
  - **Bottom** – bottom edge of the cross-section at the end of member 1D part is aligned to the bottom edge of the cross-section at the beginning of member 1D part.
  - **General** – the alignment is defined by eccentricity at the end of member 1D part:
    - **Eccentricity Z** – input distance between the center of gravity of cross-section and member axis at the end of member 1D part.

Properties group **Position** – definition of the position of member 1D part:

- **M- Master** – select item, to which the current member 1D part is related.
- **MP – Master point** – select point of the Master item, to which the insert point of current member 1D part is placed.
- **IP – Insert point** – select point of the current member 1D part, which is placed to the selected Master point.
- **X – position** – input distance of LCS of member 1D part from the GCS origin in X-axis of GCS direction or distance between Insert point and Master point in the x-axis direction of LCS of Master item for member 1D part related to another item.
- **Z – position** – input distance of LCS of member 1D part from the GCS origin in Y-axis of GCS direction or distance between Insert point and Master point in the y-axis direction of LCS of Master item for member 1D part related to another item.

## 6.2.2 Dapped end

Sub-region of **Dapped end** type adds a notch of member 1D part defined by length and height into the discontinuity region. The side edge of the notch may be inclined.

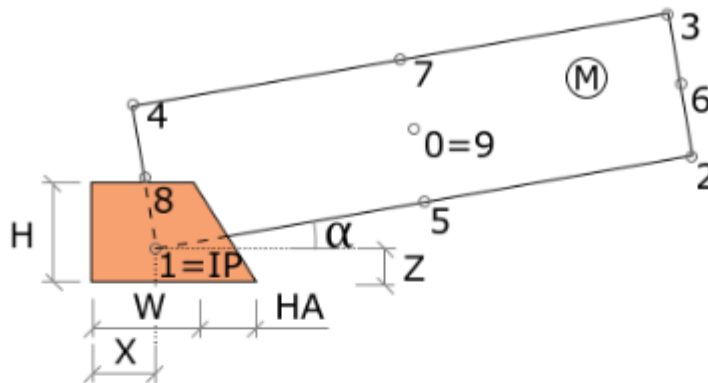

### Subregions & Details

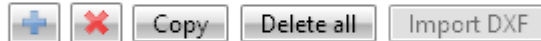

Name	Type
M1	Member 1D
> DE1	Dapped end
PS1	Point support

Dapped end	
W - Width [m]	0,60
H - Height [m]	0,85
Haunch type	None
α - Rotation XZ [°]	0,0

Position	
M - Master	M1
MP - Master point	1
X - position [m]	0,00
Z - position [m]	0,00

Properties group **Dapped end**:

- **W – Width** – input width of the dapped end.
- **H – Height** – input height of dapped end.
- **Haunch type** – select type of inclination of side edges of the dapped end:
  - **None** – side edges of the dapped end are not inclined.
  - **Left** – left edge of the dapped end is inclined.
  - **Right** – right edge of dapped end is inclined
  - **Both** – both vertical edges of the dapped end are inclined:
    - **HA – haunch** – input value of the inclination of the side edge of the dapped end.
- **α – Rotation XZ** – input value of rotation of dapped end in XZ-plane about the LCS origin of the dapped end or about the insert point.

Properties group **Position** – definition of the position of the dapped end:

- **M - Master** – select item, to which the current dapped end is related.
- **MP – Master point** – select point of the Master item, to which the insert point of the current dapped end is placed.
- **X – position** – input distance of LCS of the dapped end from the GCS origin in X-axis of GCS direction or distance between Insert point and Master point in the x-axis direction of LCS of Master item for dapped end related to another item.
- **Z – position** – input distance of LCS of the dapped end from the GCS origin in Y-axis of GCS direction or distance between Insert point and Master point in the y-axis direction of LCS of Master item for dapped end related to another item.

### 6.2.3 Wall

The sub-region of **Wall** type adds a part of the wall defined by outline and thickness into the current discontinuity region.

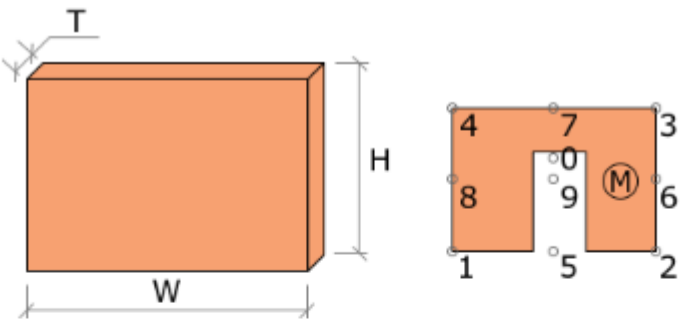

The diagram shows two wall types. On the left is a rectangular wall with width  $W$ , height  $H$ , and thickness  $T$ . On the right is a polygonal wall with vertices numbered 1 through 9, and a material symbol  $M$  inside.

**Subregions & Details** + × Copy Delete all Import DXF

Name	Type
> W1	Wall
O1	Opening
O2	Opening
LS1	Line support
LS2	Line support
LS3	Line support

Wall	
Shape	Rectangular
W - Width [m]	5,00
H - Height [m]	3,00
T - Thickness [m]	0,20
Material	C30/37
Position	
X - position [m]	0,00
Z - position [m]	0,00

Properties group **Wall**:

- **Shape** – select the wall shape:
  - **Rectangular**
    - **W – Width** – input width of the wall.
    - **H – Height** – input height of the wall.
  - **Polygon** – wall defined by a table of vertices coordinates:
    - **Edit shape** – display table to input the coordinates of vertices of the polygonal outline of the wall – see **Table editor**.
- **T – Thickness** – input the wall thickness.
- **Material** – select material of the wall. Click  to add new material to the project.

Properties group **Position** – definition of the position of the wall:

- **X – position** – input the distance of LCS of the wall from the GCS origin in direction of the X-axis of GCS.
- **Z – position** – input the distance of LCS of the wall from the GCS origin in the direction of the Y-axis of GCS.



### 6.2.3.1 Import of wall geometry from DXF

To create new wall geometry by importing from DXF file click **Import DXF** above the **Subregions and details** table.

Following entities can be imported from the DXF file: LINE, POLYLINE, SPLINE, ARC, CIRCLE, TEXT. Blocks are not imported, it is necessary to explode them to individual entities before importing.

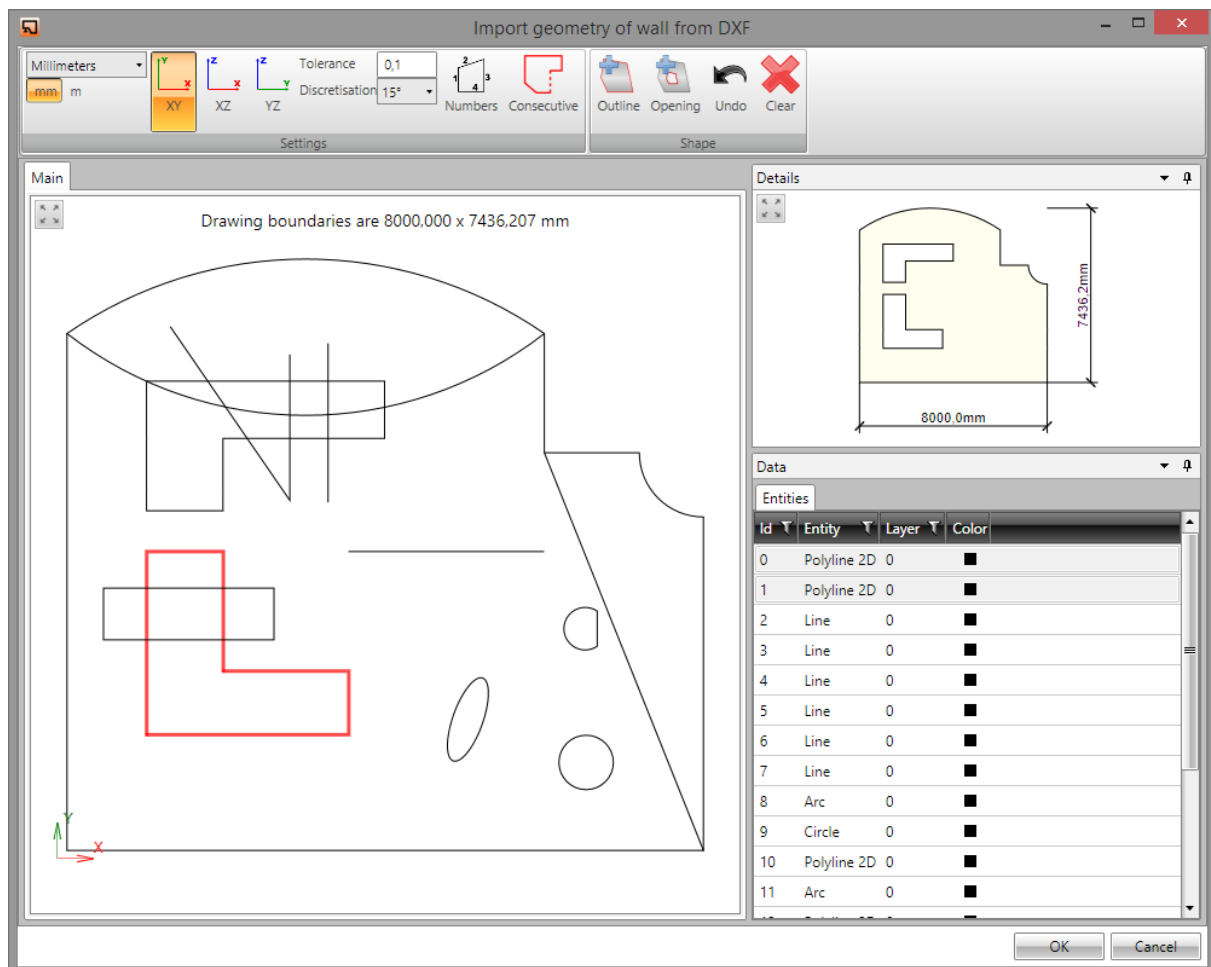

The content of imported DXF file is displayed in the dialog **Import geometry of wall from DXF**.

The proper units, which correspond to units of DXF file, must be set in ribbon group **Settings**. Otherwise, the dimensions of the wall can be wrong.

The lines, which create the shape of one part of the wall, should be selected in the main window. The selected group of lines should be continuous and should create a closed polygon.

Lines, which create wall outline or opening, must be selected in the main window. Lines can be selected like standard irregular selections in Windows applications – hold CTRL and select single lines. To select lines, which are consecutive to the selected line, click **Consecutive** in the ribbon group **Settings**.

The selected group of lines must be converted to:

- The wall outline. To convert the lines click **Outline** in the ribbon group **Shape**.
- The wall opening. To convert the lines click **Opening** in the ribbon group **Shape**.

The converted outlines and openings are drawn in the Detail window. Click **Clear** in ribbon group **Shape** to delete the converted parts of the cross-section.

## 6.2.4 Opening

The sub-region of **Opening** type adds a rectangular, circular or polygonal opening into the current discontinuity region.

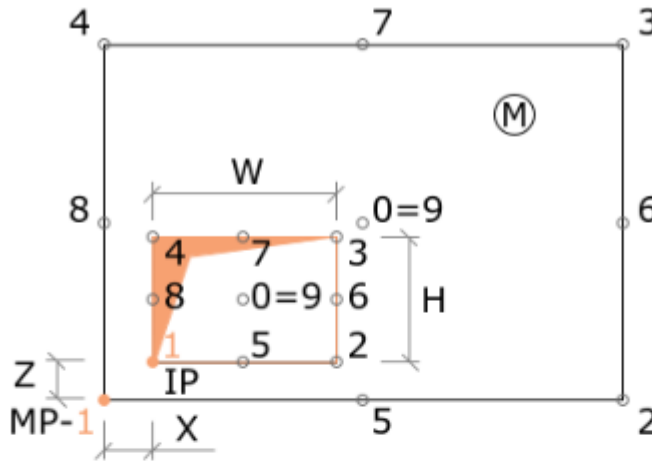

**Subregions & Details** + × Copy Delete all Import DXF

Name	Type
M1	Member 1D
M2	Member 1D
PS1	Point support
> O1	Opening

**Opening**

Shape: Rectangular

W - Width [m]:

H - Height [m]:

$\alpha$  - Rotation XZ [°]:

**Position**

M - Master: M2

MP - Master point: 8

IP - Insert point: 8

X - position [m]:

Z - position [m]:

Properties group **Opening**:

- **Shape** – select the opening shape:
  - **Rectangular**:
    - **W – Width** – input the opening width.
    - **H – Height** – input the opening height.
  - **Circular**:
    - **Diameter** – input the opening diameter.
  - **Polygon** – opening defined by a table of vertices coordinates:
    - **Edit shape** – display table to input the coordinates of vertices of polygonal opening – see **Table editor**.
- **$\alpha$  – Rotation XZ** – input value of rotation of opening in XZ- plane about the LCS origin of opening or about the insert point. It is not available for walls.

Properties group **Position** – definition of the position of the opening:

- **M - Master** – select item, to which the current opening is related.
- **MP – Master point** – select point of the Master item, to which the insert point of current opening is placed.
- **IP – Insert point** – select point of the current opening, which is placed to the selected Master point.
- **X – position** – input distance of LCS of the opening from the GCS origin in X-axis of GCS direction or distance between Insert point and Master point in the x-axis direction of LCS of Master item for opening related to another item.
- **Z – position** – input distance of LCS of opening from the GCS origin in Y-axis of GCS direction or distance between Insert point and Master point in the y-axis direction of LCS of Master item for opening related to another item.

## 6.3 Supports

### 6.3.1 Point distributed support

**Point distributed support** adds a new support into the current discontinuity region. The support is distributed along the defined edge so that no abrupt changes of distributed stress appear.

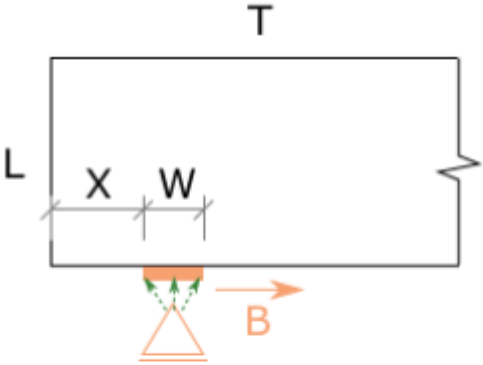

**Subregions & Details** + - Copy Delete all Import DXF

Name	Type
M1	Member 1D
M2	Member 1D
> DPS1	Distributed point

Point support	
X	<input checked="" type="checkbox"/>
Z	<input checked="" type="checkbox"/>
Ry	<input type="checkbox"/>
W - Width [m]	0,20
Position	
M - Master	M1
Position defined	On edge
Edge	Bottom
Measured from	From beginning
X - Position [m]	0,10

Properties group **Point support**:

- **X** – switch on/off the support resisting translations in the direction of global X-axis.
- **Z** – switch on/off the support resisting translations in the direction of global Z-axis.
- **Ry** – switch on/off the support resisting rotations about the global Y-axis.
- **W - Width** – input length, to which is the support distributed along the edge (for support positioned to the edge).
- **R - effective diameter** – input diameter of the area, which is used for transfer of distributed point support to the wall (for support positioned to the master point).

Properties group **Position** – definition of the position of the distributed point support:

- **M - Master** – select item, to which the current support is related.
- **Position defined** – select mode of support position definition:
  - **On edge** – position of support is related to the edge:
    - **Edge** – select edge of Master item, to which is the support related.
    - **Measured from** – select origin, to which the support position is defined:
      - **From beginning** – distance of support is related to the beginning of selected edge.
      - **From end** – distance of support is related to the end of the selected edge.
  - **Relative to master point** – support position is defined to selected point:
    - **MP – Master point** – select point of the Master item, to which the insert point of current support is placed.
    - **X – position** – input distance of support from the Master point in direction of x-axis of LCS of Master item.
    - **Z – position** – input distance of support from the Master point in direction of z-axis of LCS of Master item.

### 6.3.2 Point bearing plate

**Point bearing** plate adds a new support into the current discontinuity region. The support is made of metal plate, which distributes concentrated reaction.

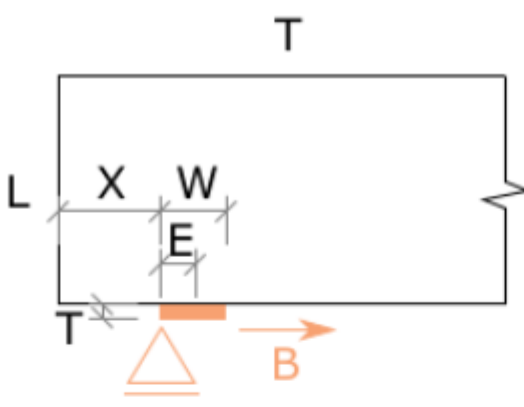

**Subregions & Details** + × Copy Delete all Import DXF

Name	Type
M1	Member 1D
M2	Member 1D
> PS1	Point support

**Point support**

X

Z

Ry

**Bearing plate for point support**

E - Eccentricity [m]

**Bearing plate**

W - Width [m]

T - Thickness [m]

Material  🔄

**Position**

M - Master

Edge

Measured from

X - Position [m]

Properties group **Point support**:

- **X** – switch on/off the support resisting translations in the direction of global X-axis.
- **Z** – switch on/off the support resisting translations in the direction of global Z-axis.
- **Ry** – switch on/off the support resisting rotations about the global Y-axis.

Properties group **Bearing plate for point support**:

- **E - Eccentricity** – input eccentricity of point support related to the center of bearing plate.

Properties group **Bearing plate**:

- **W - Width** – input width of the bearing plate.
- **T - Thickness** – input thickness of the bearing plate.

- **Material** – select material of the bearing plate. Click  to add new material to the project.

Properties group **Position** – definition of the position of the bearing plate support:

- **M - Master** – select item, to which the current support is related.
- **Edge** – select one of the edges of Master item, to which the support is related.
- **Measured from** – select origin, to which the support position is defined:
  - **From beginning** – distance of support is related to the beginning of selected edge.
  - **From end** – distance of support is related to the end of the selected edge.
- **X – position** – input distance of bearing plate edge from the selected origin.

### 6.3.3 Line support

**Line support** adds a new support into the current discontinuity region. The support is distributed along the defined length of the edge. Line support may be rigid or flexible, with linear behavior or acting in pressure only.

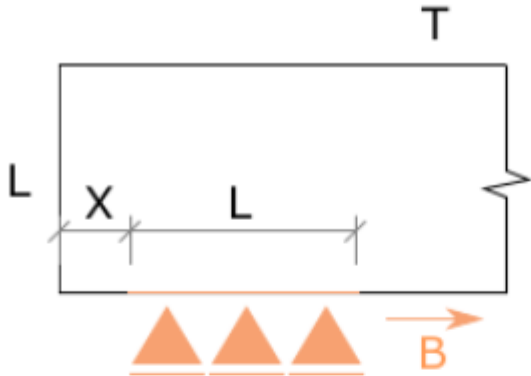

**Subregions & Details** + × Copy Delete all Import DXF

Name	Type
M1	Member 1D
M2	Member 1D
> LS1	Line support

**Flexible line support**

X

Z

Ry

Direction Local

---

**Position**

Type of input On edge

M - Master M1

Edge Bottom

Position on edge Part of edge

Measured from From beginning

X - Position [m]

L - Length [m]

Properties group **Flexible line support**:

- **X** – switch on/off the support resisting translations in the direction of X-axis of the selected coordinate system. Click  to change the support stiffness in the direction (not available for walls).
- **Z** – switch on/off the support resisting translations in the direction of Z-axis of the selected coordinate system. Click  to change the support stiffness in the direction (not available for walls). Click  to switch on/off to set the support acting as pressure only (not available for walls).
- **Ry** – switch on/off the support resisting rotations about the Y-axis of the selected coordinate system.



- **Direction** – select the coordinate system, in which the support acts:
  - **Global** – the support acts in directions of the global coordinate system.
  - **Local** – the support acts in directions of edge local coordinate system.

Properties group **Position** – definition of the position of the support:

- **Type of input** – select mode for support position definition:
  - **On edge** – support position is related to the edge.
    - **M - Master** – select item, to which the current support is related.
    - **Edge** – select one of the edges of Master item, to which the support is related.
    - **Position on edge:**
      - **Whole length** – the line flexible support acts along the whole length of the selected edge.
      - **Part of edge** – the line flexible support acts along the specified part of selected edge:
        - **Measured from** – select origin, to which the support position is defined:
          - **From beginning** – distance of line support beginning is related to the beginning of selected edge.
          - **From end** – distance of line support end is related to the end of the selected edge.
        - **X – Position** – input distance between beginning/end of line support and selected origin.
        - **L – Length** – input length of line support.
    - **By polyline** – polygonal line support defined by a table of vertices coordinates:
      - **Edit shape** – display table to define coordinates of polygon vertices – see **Table editor**.

### 6.3.4 Hanging support

**Hanging support** adds a new point support into the current discontinuity region. The point support is defined by lifting anchor. Hanging support may be lifting stud/loop, lifting socket or tensile anchor (steel plate).

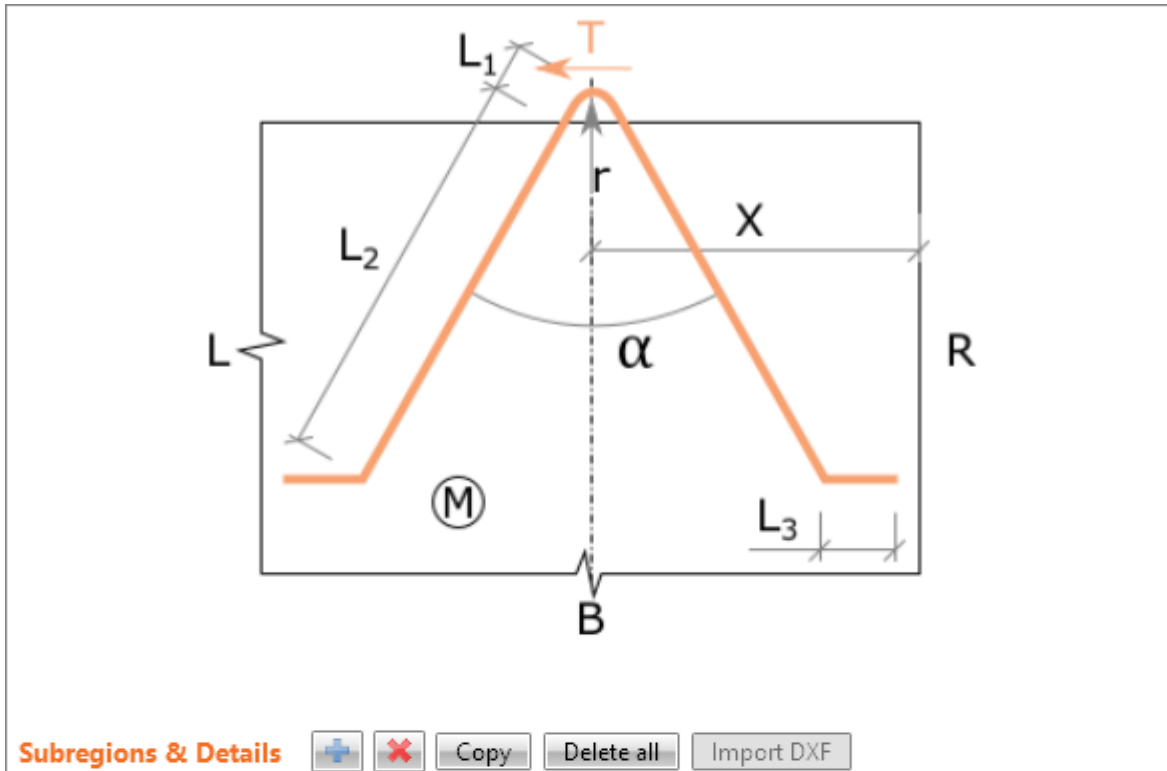

Subregions & Details

Name	Type
M1	Member 1D
M2	Member 1D
> HG1	Hanging

**Hanging**

Support rotation [°]

Shape

L1 [m]

L2 [m]

L3 [m]

r [m]

α [°]

---

**Reinforcement**

Φ - Diameter [mm]

Material

Anchorage type

Mandrel diameter  Φ

---

**Position**





M - Master

Edge



Measured from

X - Position [m]

Properties group **Hanging**:

- **Support rotation** – input rotation of point support, which is assigned to hanging, about the axis perpendicular to XZ-plane.
- **Shape** – select shape of hanging:
  -  - lifting anchor with L-shaped branches inclined to the related edge.
  -  - lifting anchor with straight branches inclined to the related edge.
  -  - lifting anchor with L-shaped branches perpendicular to the related edge.
  -  - lifting anchor with straight branches perpendicular to the related edge.
  -  - lifting stud.
  - **L1 - L3** – input lengths of individual anchor branches.
  - **r** – input mandrel diameter of lifting anchor.
  - **$\alpha$**  – input angle between lifting anchor branches.

Properties group **Reinforcement**:

- **$\emptyset$  – Diameter** – input diameter of lifting anchor bar.
- **Material** – select material of the lifting anchor bar. Click  to add new material to the project.
- **Anchorage type** – select bar anchorage type to calculate the anchoring length – see **Longitudinal bar anchorage types**.
- **Mandrel diameter** - automatically determined mandrel diameter is displayed. Click  to edit the calculated value.

Properties group **Position** – definition of the position of hanging support:

- **M - Master** – select item, to edge of which the hanging support is related.
- **Edge** – select one of the edges of Master item, to which the support is related.
- **Measured from** – select origin, to which the hanging support position is defined:
  - **From beginning** – distance of hanging support is related to the beginning of selected edge.
  - **From end** – distance of hanging support is related to the end of the selected edge.
- **X – Position** – input distance of hanging center from the selected origin.

### 6.3.5 Patch support

**Patch support** adds into the current discontinuity region a new point support distributed over a specified area. The reaction will be transmitted into the reinforcement adjacent to related patch support - e.g. steel plate welded to the reinforcement, transverse secondary beam acting on primary beam, etc.

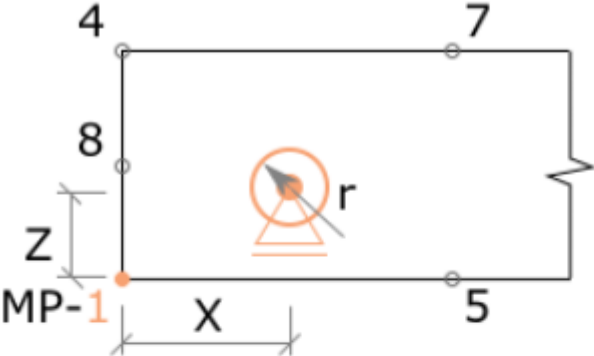

**Subregions & Details** + ✖ Copy Delete all Import DXF

Name	Type
M1	Member 1D
M2	Member 1D
> PSL1	Patch support

<b>Patch support</b>	
X	<input checked="" type="checkbox"/>
Z	<input checked="" type="checkbox"/>
Support rotation [°]	0,0
r - effective radius [m]	0,10
<b>Position</b>	
M - Master	M2
MP - Master point	1
X - position [m]	1,00
Z - position [m]	0,50

Properties group **Patch support**:

- **X** – switch on/off the support resisting translations in the direction of global X-axis.
- **Z** – switch on/off the support resisting translations in the direction of global Z-axis.
- **Support rotation** – input of rotation of point support, which is assigned to the patch support.
- **R - effective diameter** – input diameter of the area, which is used for transfer of patch support to the wall.

Properties group **Position** – definition of the position of the patch support:



- **M – Master** – select item, to which the current support is related.
- **MP – Master point** – select point of the Master item, to which the patch support is related.
- **X – position** – input distance of support from the Master point in direction of x-axis of LCS of Master item.
- **Z – position** – input distance of support from the Master point in direction of z-axis of LCS of Master item.

## 6.4 Load transfer devices

### 6.4.1 Bearing plate

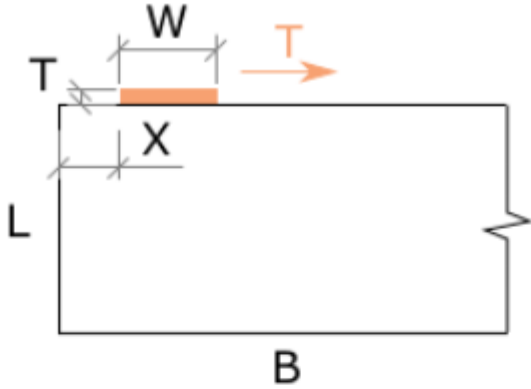
**Bearing plate** adds into the current discontinuity region a new metal plate to distribute point load. Point load can be assigned to the existing bearing plate.



**Subregions & Details**  

Name	Type
M1	Member 1D
M2	Member 1D
PSL1	Patch support
> BP1	Bearing plate

**Bearing plate**

W - Width [m]

T - Thickness [m]

Material  

**Position**

M - Master

Edge

Measured from

X - Position [m]

Properties group **Bearing plate**:

- **W - Width** – input width of the bearing plate.
- **T – Thickness** – input thickness of the bearing plate.
- **Material** – select material of the bearing plate. Click  to add new material to the project.

Properties group **Position** – definition of the position of the bearing plate:

- **M - Master** – select item, to edge of which the current bearing plate is related.
- **Edge** – select one of the edges of Master item, to which the bearing plate is related.
- **Measured from** – select origin, to which the bearing position is defined:
  - **From beginning** – distance of bearing plate is related to the beginning of selected edge.
  - **From end** – distance of bearing plate is related to the end of the selected edge.
- **X – position** – input distance of bearing plate edge from the selected origin.

### 6.4.2 Hanging load

**Hanging load** adds a hanging anchor into the current discontinuity region. Point load can be assigned to the existing hanging load.

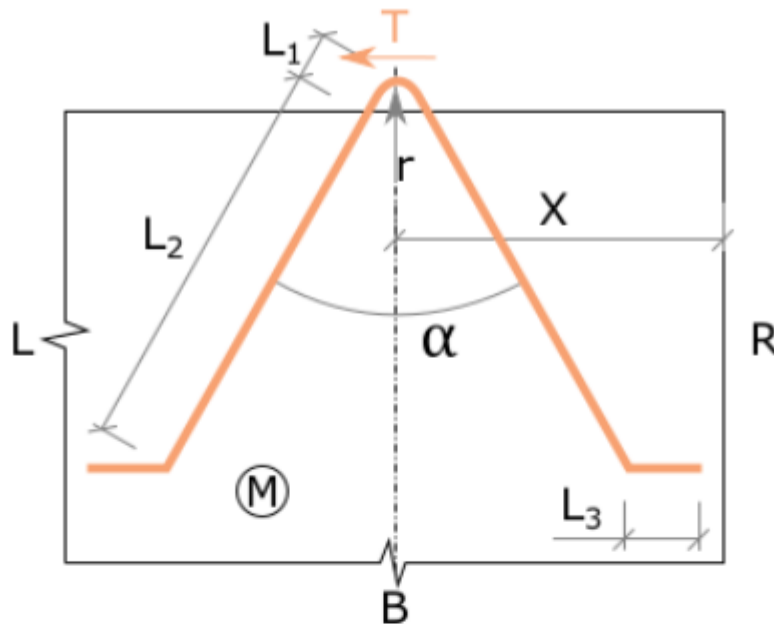





**Subregions & Details**

Name	Type
M1	Member 1D
M2	Member 1D
> HG2	Hanging



<p>▲ Hanging</p>	
Shape	<input type="button" value="Shape 1"/> <input type="button" value="Shape 2"/> <input type="button" value="Shape 3"/> <input type="button" value="Shape 4"/> <input type="button" value="Shape 5"/>
L1 [m]	0,20
L2 [m]	0,80
L3 [m]	0,50
r [m]	0,05
α [°]	29,8
<p>▲ Reinforcement</p>	
Φ - Diameter [mm]	20
Material	B 500B
Anchorage type	<input type="button" value="Anchorage 1"/> <input type="button" value="Anchorage 2"/> <input type="button" value="Anchorage 3"/> <input type="button" value="Anchorage 4"/> <input type="button" value="Anchorage 5"/> <input type="button" value="Anchorage 6"/>
Mandrel diameter	7,00 <input type="button" value="Φ"/> <input type="button" value="Edit"/>
<p>▲ Position</p>	
M - Master	M1
Edge	Top
Measured from	From beginning
X - Position [m]	1,40

Properties group **Hanging**:

- **Shape** – select shape of hanging:

-  - lifting anchor with L-shaped branches inclined to the related edge.
-  - lifting anchor with straight branches inclined to the related edge.
-  - lifting anchor with L-shaped branches perpendicular to the related edge.
-  - lifting anchor with straight branches perpendicular to the related edge.
-  - lifting stud.
- **L1 - L3** – input lengths of individual anchor branches.
- **r** – input mandrel diameter of lifting anchor.
- **$\alpha$**  – input angle between lifting anchor branches.

Properties group **Reinforcement**:

- **$\emptyset$  – Diameter** – input diameter of lifting anchor bar.
- **Material** – select material of the lifting anchor bar. Click  to add new material to the project.
- **Anchorage type** – select bar anchorage type – see **Longitudinal bar anchorage types**.
- **Mandrel diameter** - automatically determined mandrel diameter is displayed. Click  to edit the calculated value.

Properties group **Position** – definition of the position of hanging load:

- **M - Master** – select item, to which the hanging load is related.
- **Edge** – select one of the edges of Master item, to which the hanging load is related.
- **Measured from** – select origin, to which the hanging load position is defined:
  - **From beginning** – distance of hanging load is related to the beginning of selected edge.
  - **From end** – distance of hanging load is related to the end of the selected edge.
- **X – Position** – input distance of hanging load from the selected origin.

### 6.4.3 Patch load

**Patch load** adds into the current discontinuity region a new area of a specified diameter, which distributes loads assigned to this area to the reinforcement adjacent to the area.

Reinforcement and load can be assigned to the existing patch load.

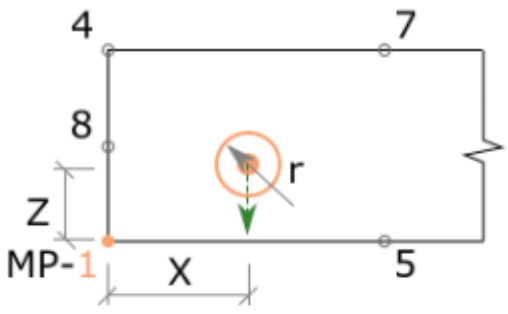

**Subregions & Details**

Name	Type
M1	Member 1D
M2	Member 1D
PSL1	Patch support
BP1	Bearing plate
> PSL2	Patch load

Patch load	
r - effective radius [m]	0,10
Position	
M - Master	M2
MP - Master point	0
X - position [m]	0,00
Z - position [m]	0,00

Properties group **Patch load**:

- **R - effective diameter** – input diameter of the area, which is used for transfer of patch load to the wall.

Properties group **Position** – definition of the position of the patch load:

- **M - Master** – select item, to which the current patch load is related.
- **MP – Master point** – select point of the Master item, to which the patch load is related.
- **X – position** – input distance of patch load from the Master point in direction of x-axis of LCS of Master item.
- **Z - position** – input distance of patch load from the Master point in direction of z-axis of LCS of Master item.



## 6.5 Load effects

Click **Discontinuity region > Loads** to define or modify loads and internal forces in the current discontinuity region.

Loads are grouped into the load cases. A summation combination can be created from the existing load cases.

Point loads, line loads or patch loads can be assigned to load case.

Each load case or combination can be selected/not selected to be taken into account in analysis and check.

Calculation and checks are performed for each defined and selected load case/combination.

Table of defined load cases and combinations and property table of the current load case are displayed in the Data window. Graphical presentation of loads in the current load case is displayed in the main window.

Ribbon groups **Loads** and **Internal forces** are displayed.

The screenshot displays the software interface with a structural model on the left and analysis results on the right. The model shows a rectangular frame with nodes 4, 7, 8, 5, and a moment MP-1 at node 1. Dimensions X1, X2, Z1, and Z2 are indicated. A load q1 is applied at an angle alpha, and q2 is applied horizontally. The analysis results on the right show a cross-section with a distributed load of -10.0 kN/m, a shear force Vz of -97.0 kN, and a bending moment My of 310.8 kNm. Below the main window, a table of load cases and combinations is visible.

Check	Name	Type
<input type="checkbox"/>	LC1	Load case
<input type="checkbox"/>	LC2	Load case
<input checked="" type="checkbox"/>	C1	Combination
<input checked="" type="checkbox"/>	C2	Combination
<input checked="" type="checkbox"/>	C3	Combination

### 6.5.1 Load cases

Load cases are modified on the tab **Load cases and combinations**. Properties of the selected load case are displayed.

Commands above the **Load cases and combinations** table:

- **+ Load case** – add a new load case into the current discontinuity region.
- **+ Combination** – add a new combination of load cases into the current discontinuity region.
-  - delete the current load case or combination.
- **Copy** – create a copy of the current load case or combination.

Columns in the table:

- **Check** – switch on/off taking into account the load case into the analysis and check.
- **Name** – input name of the current load case.
- **Type** – type of load case is printed.

### 6.5.1.1 Load case properties

Properties group **Load case**:

- **Type** – select type of load case:
  - **Permanent** – loads in the current load case are considered as permanent loads.
  - **Variable** - loads in the current load case are considered as variable loads.

### 6.5.1.2 Combination properties

Properties group **Limit state**:

- **ULS** - if selected, ULS check results are calculated for such combination.
- **SLS** - if selected, SLS check results are calculated for such combination. The selected type of SLS combination determines the analyzed types of checks.
  - **Characteristic** - the combination is considered as Characteristic combination.
  - **Quasi-permanent** - the combination is considered as Quasi-permanent combination.

Properties group **Combinations**:

- **Combination rule** – click  to display a dialog containing a table of coefficients of load cases in summation combination. In the dialog, coefficients of load case in combination can be modified, summation combinations can be added /deleted.

## 6.5.2 Internal forces in sections or supports

For each load case, values of internal forces taken from the static analysis must be defined in the table **Internal forces in supports/sections** so, that the forces acting on discontinuity region are in equilibrium.

The rows in the table are generated automatically respecting the supports/sections in discontinuity region.

Load cases & Combinations						
		Internal forces			Load impulses	
<b>Internal forces in supports/sections</b>						
Current load case		LC1				
	Member	X [m]	Position	N [kN]	Vz [kN]	My [kNm]
>	M1	0,20	Left	0,0	0,0	0,0
	M1	0,20	Right	0,0	125,0	0,0

### 6.5.3 Load impulses

Loads in current load case are defined on the tab **Load impulses**. Point loads, line loads or surface loads can be defined.

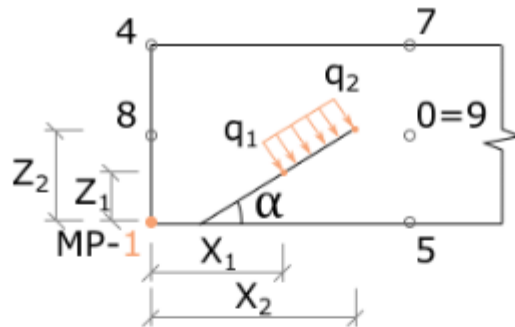

Load cases & Combinations Internal forces Load impulses

**Load impulses** Copy Delete all

Current load case LC1

Name	Type
> LL1	Line load
LL2	Line load

**Line load**

q [kN/m] -10 -10

Direction Global Z

Inclination [°] 0,0

**Position**

Defined On edge

M - Master M1

Edge Top

Position on edge Part of edge to end

Measured from From beginning

Position on edge [m] 0,20

Commands above the table **Load impulses**:

- add a new load impulse to the current load case. The type of impulse is selected in the following dialog.
- delete the current load impulse.
- Copy** – create a copy of the current load impulse.
- Delete all** – delete all impulses from the current load case.
- Current load case** – select the current load case to add/modify load impulses.

### 6.5.3.1 Point load

Point load is defined by its size and direction. The position of point load can be specified or the load can be related to existing device for transfer of loads – patch loads defined in **Geometry**.

▲ Point load	
Q [kN]	-10,0
Direction	Global Z
Inclination [°]	0,0
r - effective radius [m]	0,10
▲ Device for transmitting a point load	
Transmitting device	None
▲ Position	
Master	M1
Defined	Relative to master point
MP - Master point	0
X - position [m]	0,00
Z - position [m]	0,00

Properties group **Point load**:

- **Q** – input of point load size.
- **Direction** – select direction of point load action:
  - **Global Z** – point load acts in the direction of global Z-axis.
  - **Global X** – point load acts in the direction of global X-axis.
- **Inclination** – input inclination angle from the specified load direction.
- **r - effective radius** – input diameter of the area, which is used for transfer of point load to the wall.

Properties group **Device for transmitting a point load**:

- **Transmitting device** – select existing device, which can be used for point load transfer – bearing plate, hanging, patch load... The position of point load is defined by the position of the device.
- **Eccentricity** – input eccentricity of load impulse to the centre of bearing plate.

Properties group **Position** – definition of the position of the point load:

- **M - Master** – select item, to which the current load is related.
- **Position defined** – select mode of load position definition:
  - **On edge** – position of the load is related to the edge:
    - **Edge** – select edge of Master item, to which is the load related.
    - **Measured from** – select origin, to which the load position is defined:
      - **From beginning** – distance of load is related to the beginning of selected edge.
      - **From end** – distance of load is related to the end of the selected edge.
    - **X – position** – input distance of load from the selected edge origin.

- **Relative to master point** – load position is defined to selected point:
  - **MP – Master point** – select point of the Master item, to which the insert point of current load is placed.
  - **X – position** – input distance of load from the Master point in direction of x-axis of LCS of Master item.
  - **Z – position** – input distance of load from the Master point in direction of z-axis of LCS of Master item.

### 6.5.3.2 Line load

Line load is determined by its size, direction, and position.

Line load	
q [kN/m]	-10 -10
Direction	Global Z
Inclination [°]	0,0
Position	
Defined	On edge
M - Master	M2
Edge	Top
Position on edge	Part of edge
Measured from	From beginning
X - Position [m]	1,00
L - Length [m]	1,00

Properties group **Line load**:

- **q** – input size of line load at the beginning and at the end.
- **Direction** – select direction of line load action:
  - **Global Z** – line load acts in the direction of global Z-axis.
  - **Global X** – line load acts in the direction of global X-axis.
  - **Local X** – line load acts in the direction of the x-axis of the local coordinate system of the item.
  - **Local Z** – line load acts in the direction of the z-axis of the local coordinate system of the item.
- **Inclination** – input inclination angle from the specified load direction.

Properties group **Position** – definition of the position of the line load:

- **Defined** – select mode of line load definition:
  - **On edge** – load position is related to the edge:
    - **M - Master** – select item, to the edge of which the current load is related.
    - **Edge** – select one of the edges of Master item, to which the support is related.
    - **Position on edge**:
      - **Whole length** – the line load acts along the whole length of the selected edge.
      - **Part of edge** – the line load acts along the specified part of selected edge:
        - **Measured from** – select origin, to which the load position is defined:
          - **From beginning** – distance of load is related to the beginning of selected edge.
          - **From end** – distance of load is related to the end of the selected edge.

- **X - position** – input distance between beginning/end of line load and selected origin.
- **L – Length** – input length of line support.
- **Part of edge to end** – line load acts along the whole edge except the defined part on the beginning/end of the edge:
  - **Measured from** – select origin, to which the load position is defined:
    - **From beginning** – distance of line load beginning is related to the beginning of selected edge.
    - **From end** – distance of line load end is related to the end of the selected edge.
  - **X - position** – input distance of line load beginning/end from the selected origin.
- **Points** – line load position is defined by coordinates of beginning and end point of line load.
- **By polyline** – polygonal line support defined by a table of vertices coordinates:
  - **Edit shape** – display table to define coordinates of polygon vertices – see **Table editor**.

Properties groups **Begin position** and **End position** – definition of beginning/end point position for input mode **Points**:

- **M - Master** – select item, to point of which is related the beginning/end point of line load.
- **Master point** – select one of the points of Master item, to which is related the position of beginning/end of line load.
- **X** – distance of line load beginning/end from:
  - the GCS beginning in the direction of X-axis of GCS.
  - the selected Master vertex in direction of x-axis of LCS of Master item.
- **Z** – distance of line load beginning/end from:
  - the GCS beginning in direction of Z-axis of GCS.
  - the selected Master vertex in direction of x-axis of LCS of Master item.

### 6.5.3.3 Surface load

The surface load is defined by its size, direction, and position. The load acts on all finite elements belonging to the selected item of discontinuity region.

▲ Surface load	
q [kN/m <sup>2</sup> ]	-10,0
Direction	Global Z
Inclination [°]	0,0
▲ Position	
Applied on	W1

Properties group **Surface load**:

- **q** – input of surface load size.
- **Direction** – select direction of surface load action:
  - **Global Z** – surface load acts in the direction of global Z-axis.
  - **Global X** – surface load acts in the direction of global X-axis.
- **Inclination** – input inclination angle from the specified load direction.

Properties group **Position**:

- **Apply on** – select the sub-region, on which the surface load acts.

### 6.5.4 Ribbon group Loads

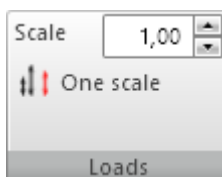

- **Scale** – input value of scale for drawing of all types of loads impulses.
- **One scale** – switches on/off drawing of all load impulse types using a unified scale not respecting the real value of the load.

### 6.5.5 Ribbon group Internal forces

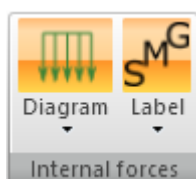

Commands in ribbon group **Internal forces** can be used to drawing settings of courses of internal forces resulting from defined external loads and defined internal forces in supports/sections.

Commands group **Diagram**:

- **N** – switch on/off drawing of course of axial force.
- **Vz** – switch on/off drawing of course of shear force.
- **My** – switch on/off drawing of course of bending moment.

Commands group **Label**:



- **No label** – switch off drawing of internal forces values in graphs.
- **Sections** – switch on drawing of internal forces values in each section of sub-region.
- **Member extremes** – switch on drawing of extreme values of internal forces in each sub-region.
- **Global extremes** – switch on drawing of extreme values of internal forces from the whole discontinuity region.

## 6.6 Reinforcement

Click **Discontinuity region > Reinforcement** to define the reinforcement of discontinuity region. Corresponding to the discontinuity region type the reinforcement can be provided using single bars, groups of bars, stirrups, fabric wires, reinforcement cages etc.

Design tools can be used to determine areas to be reinforced – topology optimisation and linear analysis.

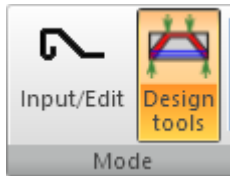

The working mode can be set in ribbon group **Mode**:

- **Input/Edit** – switches to input/edit of real reinforcement.
- **Design tools** – switches to the calculation of reinforcement distribution.

### 6.6.1 Design of reinforcement distribution

Topology optimisation calculation or linear calculation can be performed to design the reinforcement distribution.

Distribution areas of compression and tension are determined during topology optimisation. The topology optimisation is calculated for a requested number of effective volumes – the structural volumes, which are expected to transfer loads.

Stress-flow is determined during linear analysis.

The current design mode can be set in ribbon group **Design tools**:

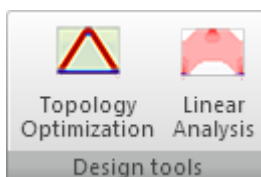

- **Topology optimisation** – performs topology optimisation analysis for required effective volume levels or switches to the evaluation of topology optimisation results.
- **Linear analysis** – performs linear analysis to determine compression and tension stress flow or switches to the evaluation of linear analysis results.

### 6.6.1.1 Topology optimisation

Click **Topology optimisation** in ribbon group **Design tools** to run analysis or to evaluate existing results of topology optimisation.

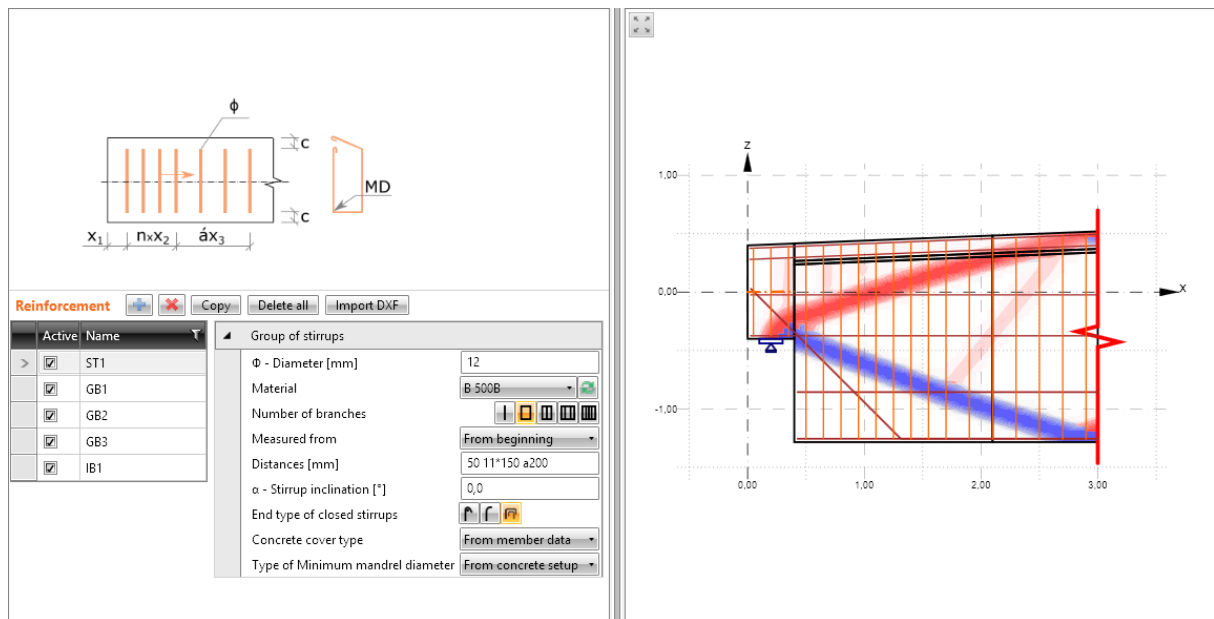

Evaluation mode can be set in ribbon group **Reinforcement positions and directions**:

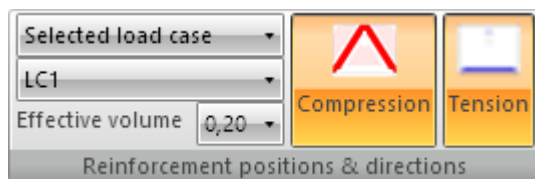

- **Evaluated load** – select, if the evaluation is performed for all load cases/combinations or only for the selected one.
- **Effective volume** – select effective volume level to draw the results of topology optimisation.
- **Compression** – switch on/off drawing of compressed areas for the current effective volume level.
- **Tension** – switch on/off drawing of tensioned areas for the current effective volume level.

### 6.6.1.2 Linear analysis

Click **Linear analysis** in ribbon group **Design tools** to run linear analysis to determine stress flow and directions or to evaluate existing results of the linear analysis.

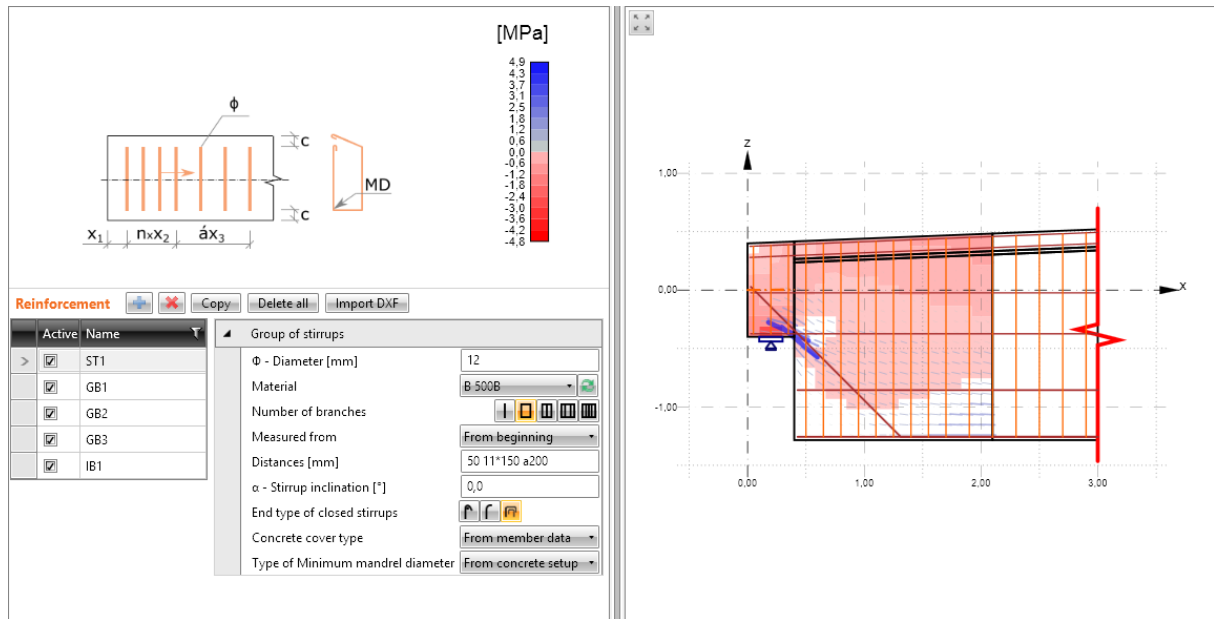

Evaluation mode can be set in ribbon group **Reinforcement positions and directions**:

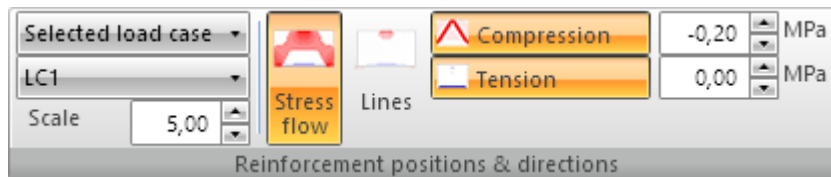

- **Evaluated load** – select, if the evaluation is performed for all load cases/combinations or only for the selected one.
- **Scale** – set the scale value for drawing of stress direction lines.
- **Stress-flow** – switch to draw areas of concrete in compression and concrete in tension.
- **Lines** – switch to draw directions of principal compression and tension stresses.
- **Compression** – switch on/off drawing of compressed areas.
- **Tension** – switch on/off drawing of tension areas.
- **Limit compression** – set the limit value for compression. Results are drawn only for areas, where the compression is higher than the limit value.
- **Limit tension** – set the limit value for tension. Results are drawn only for areas, where the tension is higher than the limit value.

### 6.6.2 Group of reinforcement bars

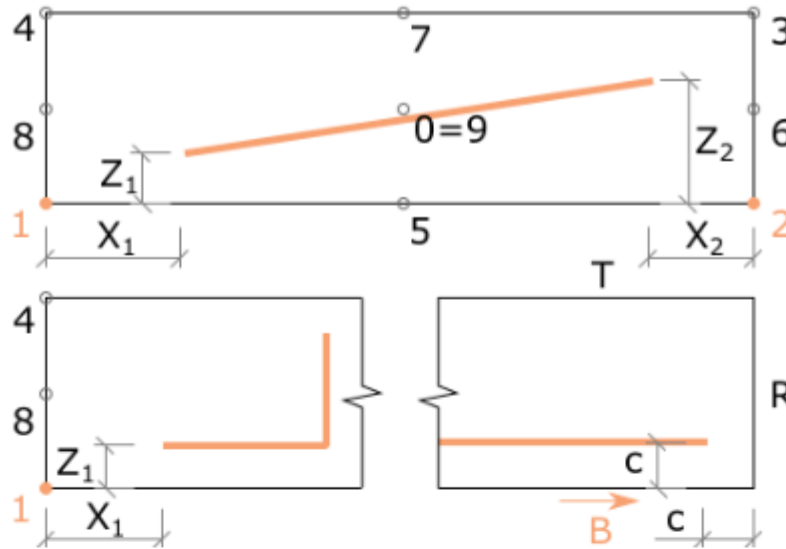

**Reinforcement**

Active	Name
<input checked="" type="checkbox"/>	ST1
> <input checked="" type="checkbox"/>	GB1
<input checked="" type="checkbox"/>	GB2
<input checked="" type="checkbox"/>	GB3
<input checked="" type="checkbox"/>	IB1

- Group of reinforcement bars

nl - Number of layers: 2

D - Distance [mm]: 400

Bar distance measured: Perpendicular to first segment
- Single reinforcement bar

Φ - Diameter [mm]: 16

Material: B 500B

n - Number of bars in layer: 2
- Shape definition

Definition of bar shape: On outline or opening edge

Anchorage type at the beginning: [Icons]

Anchorage type at the end: [Icons]
- Edge component data

M - Master: M2

Edge: Bottom

Position on edge: [Icons]

Extension of beginning: [Icons]

Extension of end: [Icons] 0 mm

Concrete cover type: From Settings
- Patch load or support

Interconnect automatically:

Properties group **Group of reinforcement bars**:

- **nl – Number of layers** – input number of layers in the group of bars.
- **D – Distance** – input distance between neighboring layers.
- **Bar distance measured** – select direction to measure the spacing between layers:
  - **Perpendicular to first segment +** - the distance between layers is measured in the positive direction of normal line of the first segment of polygon defining the bar in layer.
  - **Perpendicular to first segment -** - the distance between layers is measured in the negative direction of normal line of the first segment of polygon defining the bar in the layer.

Properties group **Single reinforcement bar** – define properties of all bars in the group:

- **∅ – Diameter** – input reinforcement bar diameter.
- **Material** – select material of the reinforcement bar. Click  to add new material to the project.
- **n – Number of bars in layer** – input number of bars in each layer.

Properties group **Shape definition** – select mode of definition of position, shape and anchorage type of bars:

- **Definition of bar shape** – select mode of bar definition:
  - **By two points** - bar position is defined by positions of beginning and end point of the bar.
  - **On outline or opening edge** – bar position is related to the edge.
  - **On more edges** – reinforcement bar is polygonal along selected edge.
  - **Polyline** – polygonal bar defined by a table of vertices coordinates:
    - **Edit shape** – display table to define coordinates of polygon vertices –see **Table editor**.
- **Anchorage type at the beginning** – see **Longitudinal bar anchorage types**.
- **Anchorage type at the end** – see **Longitudinal bar anchorage types**.
- **Mandrel diameter** - automatically determined mandrel diameter is displayed. Click  to edit the calculated value.

Properties group **Patch load or support**:

- **Interconnect automatically** – if selected, patch loads/supports adjacent to the reinforcement are found and connected to reinforcement so, that the reinforcement transfers load effect-s/reactions.

### 6.6.2.1 Bar defined by two points

Reinforcement bar is defined by a beginning point and end point.

Shape definition	
Definition of bar shape	By two points
Anchorage type at the beginning	
Anchorage type at the end	
Begin position	
M - Master	M2
Master point	1
X [mm]	0
Z [mm]	0
End position	
Master	M2
Master point	2
X [mm]	1000
Z [mm]	0

Properties groups **Begin position** and **End position** – definition of beginning/end point position for input mode **By two points**:

- **M - Master** – select item, to point of which the position of bar beginning/end point is related.
- **Master point** – select point of the Master item, to which the position of bar beginning/end point is related.
- **X** – distance of bar beginning/end from:
  - the GCS beginning in direction of X-axis of GCS.
  - the selected Master point in direction of x-axis of LCS of Master item.
- **Z** – distance of bar beginning/end from:
  - the GCS beginning in direction of Z-axis of GCS.
  - the selected Master point in direction of x-axis of LCS of Master item.

### 6.6.2.2 Bar along the edge

The reinforcement bar is defined along part or the whole length of the selected edge.

Shape definition	
Definition of bar shape	On outline or opening edge
Anchorage type at the beginning	
Anchorage type at the end	
Edge component data	
M - Master	M2
Edge	Bottom
Position on edge	
Extension of beginning	
Extension of end	500 mm
Concrete cover type	From Settings

Properties group **Edge component data**:

- **M - Master** – select item, to the edge of which the bar is related.
- **Edge** – select one of the edges of Master item, to which the bar is related.
- **Position on edge**:
  - - whole length. The reinforcement bar is along the whole length of the selected edge.
  - - edge part from beginning. The reinforcement bar is along the whole length of the selected edge except the defined gap at the beginning of the edge:
    - **Position**– input distance of the beginning of bar from the beginning of edge.
    - **Length** – input length of the bar.
  - - edge part from end. The reinforcement bar is along the whole length of the selected edge except the defined gap at the end of the edge:
    - **Position**– input distance of the end of the bar from the end of the edge.
    - **Length** – input length of the bar.
  - - whole length and extension. The reinforcement bar is along the whole length of the selected edge and may be extended:
    - **Extension on beginning/end**:
      - - no extension. Reinforcement bar along the whole edge is not extended at the beginning/end.
      - - extended to outer edge. The reinforcement bar is along the whole selected edge and at the beginning/end of the bar is extended to the outermost edge of whole discontinuity region.



-  - extended by length. The reinforcement bar is along the whole selected edge and at the beginning/end of the bar is extended by the specified length.
- **Concrete cover type** – select mode of cover definition:
  - **From Settings** – the concrete cover value is taken from the Settings associated with the master item.
  - **User value** – concrete cover is defined by user:
    - **Cover** – input value of concrete cover.

### 6.6.2.3 Bar along more edges

Reinforcement bar is defined along multiple edges that define the polygonal shape of the reinforcement bar.

Shape definition	
Definition of bar shape	On more edges
Anchorage type at the beginning	
Anchorage type at the end	
Mandrel diameter	4,00 $\Phi$
Edge component data	
M - Master	Outline all members
Edges	1 2
First edge	<input type="checkbox"/>
Last edge	<input type="checkbox"/>
Concrete cover type	From Settings

Properties group **Edge component data**:

- **M - Master** – select item, to the edge of which the bar is related.
- **Edges** – space-separated sequence of edges along which the bar is defined.
- **First edge** – if selected, the length of the bar along the first edge can be specified. The length is measured from the intersection of the first edge and next edge in the specified sequence.
- **Last edge** – if selected, the length of the bar along the last edge can be specified. The length is measured from the intersection of the last edge and previous edge in the specified sequence.
- **Concrete cover type** – select mode of cover definition:
  - **From Settings** – the concrete cover value is taken from the Settings associated with the master item.
  - **User value** – concrete cover is defined by user:
  - **Covers** – input sequence of cover values along the edges.

### 6.6.3 Bent-up bar

Bent-up bar creates a bar bent between the top and bottom edge of the selected subregion.

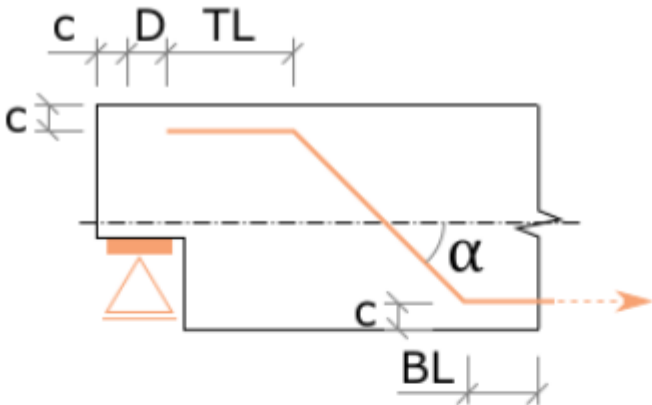

**Reinforcement**

Active	Name
<input checked="" type="checkbox"/>	ST1
<input checked="" type="checkbox"/>	GB1
<input checked="" type="checkbox"/>	GB2
<input checked="" type="checkbox"/>	GB3
<input checked="" type="checkbox"/>	IB1
>	<input checked="" type="checkbox"/> BU2

**Inclined reinforcement bar**

M - Diameter [mm]

Material

n - Number of bars in layer

Anchorage type at the beginning

Anchorage type at the end

Concrete cover type

---

**Reinforcement bar**

M - Master

Left/Right

TL - Top length [mm]

BL - Bottom length [mm]

Angle [°]

Distance from left/right edge [mm]

Anchoring bar

Mandrel diameter

---

**Patch load or support**



Interconnect automatically

Properties group **Inclined reinforcement bar**:

- **∅ – Diameter** – input diameter of reinforcement bar.
- **Material** – select material of the reinforcement bar. Click  to add new material to the project.
- **n – Number of bars in layer** – input number of bars in each layer.
- **Anchorage type at the beginning** - see [Longitudinal bar anchorage types](#).

- **Anchorage type at the end** - see **Longitudinal bar anchorage types**.
- **Concrete cover type** – select mode of cover definition:
  - **From Settings** – the concrete cover value is taken from the Settings associated with the master item.
  - **User value** – concrete cover is defined by user:
    - **Cover** – input value of concrete cover.

Properties group **Reinforcement bar**:

- **M - Master** – select item, to which the bent-up bar is related.
- **Left/Right** – bent-up bar is created at the left () or the right () edge of the master item.
- **TL – Top length** – input length at the top edge of the master item.
- **BL – Bottom length** – input length at the bottom edge of the master item.
- **Angle** – input inclination angle of the bent-up bar.
- **Distance from left/right edge** – input distance of the beginning point of the bent-up bar from the left/right edge of the master item.
- **Anchoring bar** – switch on/off adding of specified anchorage length to the beginning of the bent-up bar.
- **Mandrel diameter** - automatically determined mandrel diameter is displayed. Click  to edit the calculated value.

Properties group **Patch load or support**:

- **Interconnect automatically** – if selected, patch loads/supports adjacent to the reinforcement are found and connected to reinforcement so, that the reinforcement transfers load effects/reactions.

### 6.6.4 Inclined reinforcement bar

Inclined reinforcement bar creates bar at the point of concave edge – dapped end, hole, wall edge etc.



**Reinforcement** + × Copy Delete all Import DXF

Active	Name
<input checked="" type="checkbox"/>	ST1
<input checked="" type="checkbox"/>	GB1
<input checked="" type="checkbox"/>	GB2
<input checked="" type="checkbox"/>	GB3
>	<input checked="" type="checkbox"/> IB1

**Inclined reinforcement bar**

M - Diameter [mm]

Material  🔄

n - Number of bars in layer

Anchorage type at the beginning 🔗 🔗 🔗 🔗 🔗 🔗 🔗 🔗

Anchorage type at the end 🔗 🔗 🔗 🔗 🔗 🔗 🔗 🔗

Concrete cover type

---

**Reinforcement bar**

Type 📏 📏

M - Master

MP - Master point

Add bar on the top   mm

Add bar on the bottom

Angle [°]

Mandrel diameter   $\phi$  🔍

---

**Patch load or support**



Interconnect automatically

Properties group **Inclined reinforcement bar**:

- $\emptyset$  – **Diameter** – input diameter of reinforcement bar.
- **Material** – select material of the reinforcement bar. Click 🔄 to add new material into the project.
- **n – Number of bars in layer** – input number of bars in each layer.
- **Anchorage type at the beginning** - see [Longitudinal bar anchorage types](#).
- **Anchorage type at the end** - see [Longitudinal bar anchorage types](#).

- **Concrete cover type** – select mode of cover definition:
  - **From Settings** – the concrete cover value is taken from the Settings associated to the master item.
  - **User value** – concrete cover is defined by user:
    - **Cover** – input value of concrete cover.

Properties group **Reinforcement bar**:

- **Type** – select input mode of inclined bar:
  -  - bar is defined by two lengths relatively to the master point:
    - **TL – Top length** – input length of bar above the master point.
    - **BL – Bottom length** – input length of bar below the master point.
  -  - the length of reinforcement bar is determined automatically. The bar can be extended along adjacent edges:
    - **Add bar on the top** – if selected, the bar above the master point is extended by specified length in the direction of the adjacent edge.
    - **Add bar on the bottom** – if selected, the bar below the master point is extended by specified length in the direction of the adjacent edge.
- **M - Master** – select item, to which the inclined bar is related.
- **MP – Master point** – select point of the Master item, to which the inclined bar is related.
- **Angle** – input inclination angle of the inclined bar.
- **Mandrel diameter** - automatically determined mandrel diameter is displayed. Click  to edit the calculated value.

Properties group **Patch load or support**:

- **Interconnect automatically** – if selected, patch loads/supports adjacent to the reinforcement are found and connected to reinforcement so, that the reinforcement transfers load effects/reactions.

### 6.6.5 Cage around the opening

Cage adds a reinforcement cage around the opening. The reinforcement cage consists of reinforcement along edges and diagonal reinforcement around corners.

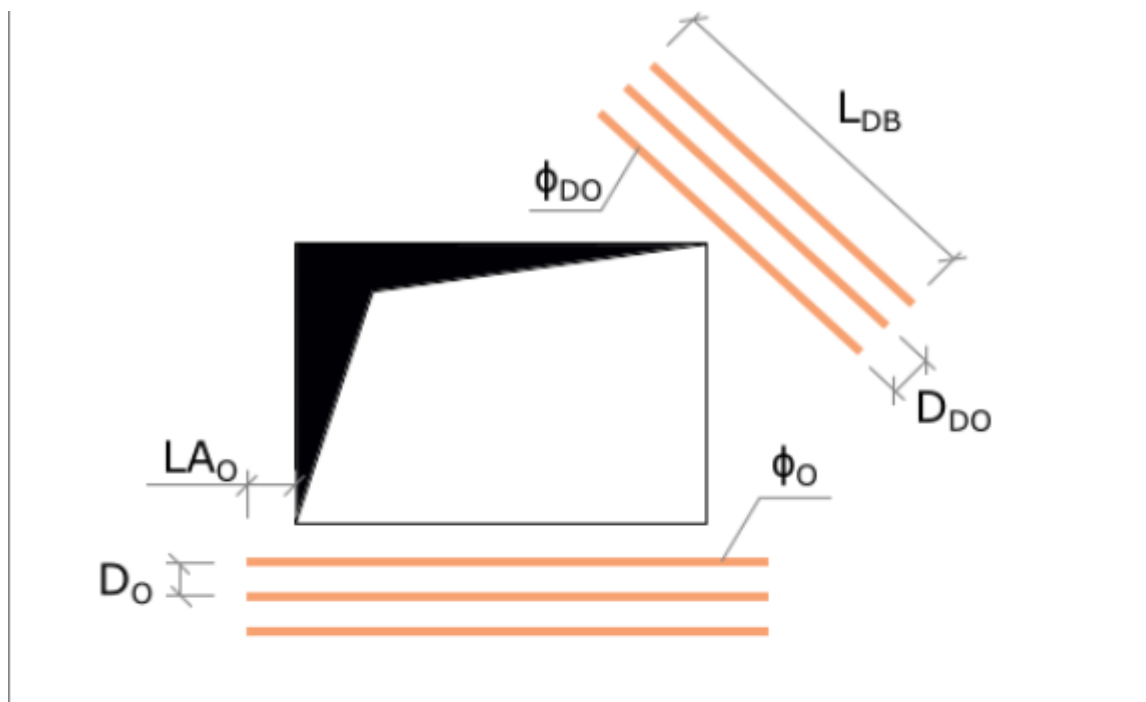

**Reinforcement** + × Copy Delete all Import DXF

Active	Name
<input checked="" type="checkbox"/>	ST1
<input checked="" type="checkbox"/>	RO1
<input checked="" type="checkbox"/>	GB1
<input checked="" type="checkbox"/>	GB2

**Reinforcement around opening or patch load/support**

$\Phi$  - Diameter [mm]

n - Number of bars in layer

Distances [mm]

Number of layers

Anchoring length [mm]

Material

Bar anchorage type

M - Master

Concrete cover type

---

**Diagonal reinforcement**

Add diagonal reinforcement

$\Phi$  - Diameter [mm]

Distances [mm]

Number of layers

Length of bars [mm]

Bar anchorage type

Properties group **Reinforcement around opening or patch/load support**:

- **∅ – Diameter** – input diameter of reinforcement bar.
- **n - Number of bars in layer** - input number of bars in individual layer (in direction perpendicular to the wall plane).
- **Distances** – input spacing between bars along edges (vertical and horizontal bars).
- **Number of layers** – input number of reinforcement layers along edges (vertical and horizontal bars).
- **Anchorage length** – input anchorage length to extend the basic length of bar.
- **Material** – select material of the reinforcement bar. Click  to add new material into the project.
- **Bar anchorage type** - see **Longitudinal bar anchorage types**.
- **M - Master** – select opening, to which the reinforcement cage is related.
- **Concrete cover type** – select mode of cover to opening edge definition:
  - **From Settings** – the concrete cover value is taken from the Settings associated to the master item.
  - **User value** – concrete cover is defined by user:
    - **Cover** – input value of concrete cover.

Properties group **Diagonal reinforcement** – properties of reinforcement around opening corners:





- **Add diagonal reinforcement** – switch on/off application of diagonal reinforcement into the reinforcement cage.
- **∅ – Diameter** – input diameter of reinforcement bar.
- **Distances** – input spacing between diagonal bars.
- **Number of layers** – input number of layers of diagonal reinforcement.
- **Length of bars** – input length of diagonal bars.
- **Bar anchorage type** - see **Longitudinal bar anchorage types**.

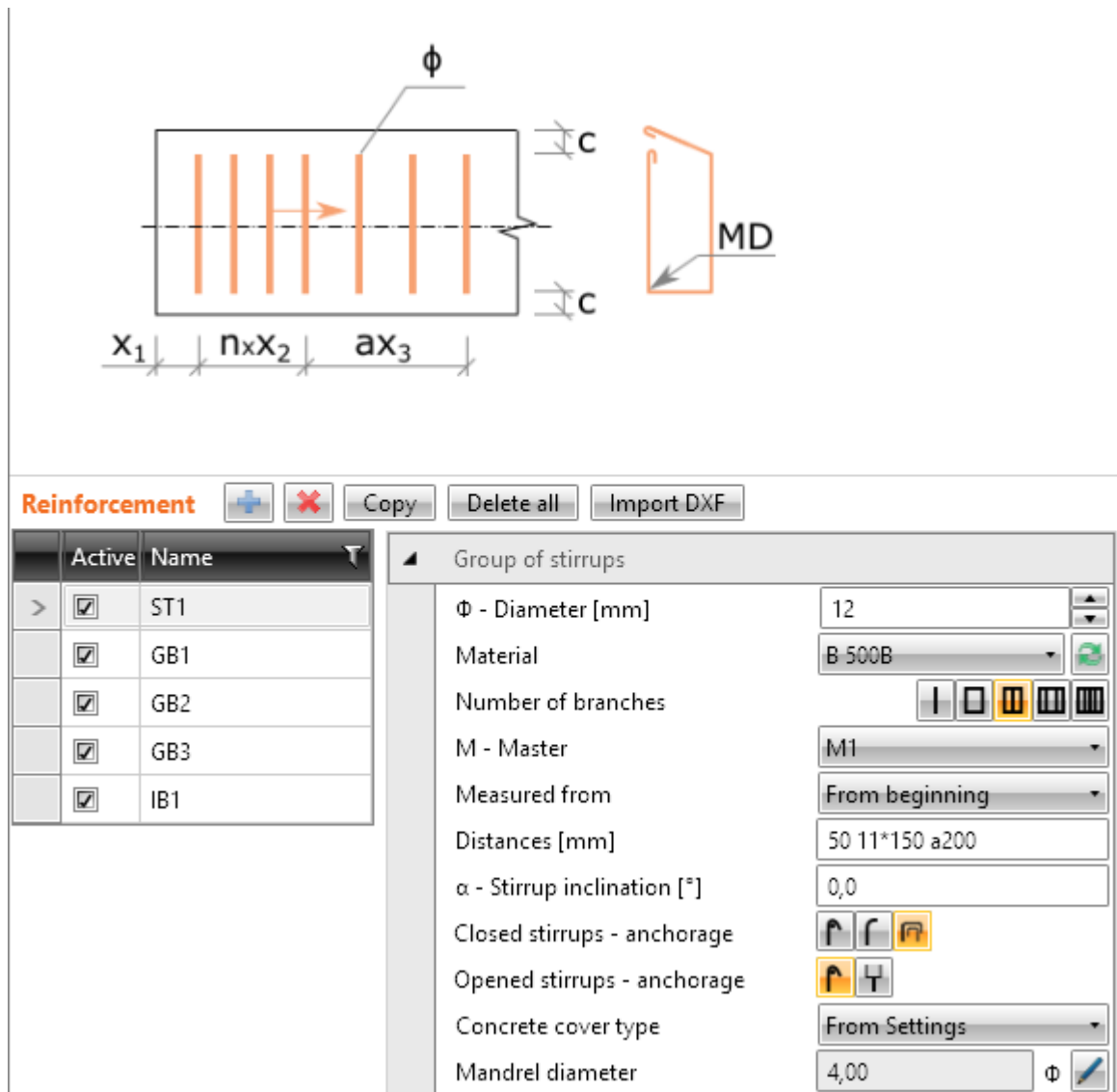

### 6.6.6 Group of stirrups





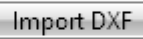





Adds a group of stirrups along the 1D discontinuity region.









**Reinforcement**     







Active	Name
<input checked="" type="checkbox"/>	ST1
<input checked="" type="checkbox"/>	GB1
<input checked="" type="checkbox"/>	GB2
<input checked="" type="checkbox"/>	GB3
<input checked="" type="checkbox"/>	IB1

**Group of stirrups**

- $\Phi$  - Diameter [mm]: 12
- Material: B 500B
- Number of branches:     
- M - Master: M1
- Measured from: From beginning
- Distances [mm]: 50 11\*150 a200
- $\alpha$  - Stirrup inclination [°]: 0,0
- Closed stirrups - anchorage:   
- Opened stirrups - anchorage:  
- Concrete cover type: From Settings
- Mandrel diameter: 4,00  $\Phi$  

Properties group **Group of stirrups**:

- $\Phi$  – **Diameter** – input diameter of the stirrup bar.
- **Material** – select material of the stirrup bar. Click  to add new material to the project.
- **Number of branches** – select type of stirrup:
  -  - switch to the input of single-legged stirrup.
  -  - switch to the input of double-legged stirrup.
  -  - switch to the input of three-legged stirrup.
  -  - switch to the input of four-legged stirrup.
  -  - switch to the input of five-legged stirrup.

- **Measured from** – select origin, to which is defined the beginning point of stirrups group:
  - **From beginning** – distance of the first stirrup in the group is related to the beginning of discontinuity region.
  - **From end** – distance of the last stirrup in the group is related to the end of discontinuity region.
- **Distances** – input sequence of stirrup distances. Distances are applied from the selected origin in the specified order. Following patterns and its combinations are available:
  - X Y Z – sequence of absolute distances from the selected origin (e.g. 50 90 130 creates three stirrups in distances 50, 90 and 130 from the selected origin).
  - A\*B – number of stirrups\*spacing (e.g. 5\*200 creates five stirrups with spacing 200 from the last existing stirrup or from the selected origin).
  - aX – fills the length without defined stirrups by stirrups with specified spacing (e.g. a200 fills the length from the last existing stirrup or from the selected origin to the end of discontinuity region with stirrups spaced by 200).
  - A/B – length/count – spreads the specified count of stirrups over specified length (e.g. 1000/5 spreads regularly 5 stirrups over the length of 1000 from the last existing stirrup or from the selected origin).
- **$\alpha$  – Stirrup inclination** – input angle of stirrup inclination from the local z-axis of the reinforced item.
- **Closed stirrups - anchorage:**
  -  - the stirrup is anchored using the standard hook.
  -  - the stirrup is anchored using standard bend.
  -  - the stirrup is anchored using legs overlap.
- **Anchorage type of closed stirrups:**
  -  - the stirrup is anchored using the standard hook.
  -  - the stirrup bar is considered to be continuous or with the perfect bond.
- **Concrete cover type** – select mode of cover definition:
  - **From Settings** – the concrete cover value is taken from the Settings associated with the master item.
  - **User value** – concrete cover is defined by user:
    - **Cover** – input value of concrete cover.
- **Mandrel diameter** - automatically determined mandrel diameter is displayed. Click  to edit the calculated value.

### 6.6.7 Cage around patch support/load

Adds a reinforcement cage into the discontinuity region . The cage is related to existing patch load/support. The cage consists of horizontal, vertical and diagonal reinforcement.

**Reinforcement** + × Copy Delete all Import DXF

Active	Name
<input checked="" type="checkbox"/>	ST1
<input checked="" type="checkbox"/>	GB1
<input checked="" type="checkbox"/>	GB2
<input checked="" type="checkbox"/>	GB3
>	<input checked="" type="checkbox"/> RP1

**Reinforcement around opening or patch load/support**

$\Phi$  - Diameter [mm]

n - Number of bars in layer

Distances [mm]

Number of layers

Length of bars [mm]

Material

Bar anchorage type

M - Master

First bar distance [mm]

---

**Diagonal reinforcement**

Add diagonal reinforcement

$\Phi$  - Diameter [mm]

Distances [mm]

Number of layers

Length of bars [mm]

Bar anchorage type

Properties group **Reinforcement around opening or patch/load support**:

- **Ø – Diameter** – input diameter of reinforcement bar.
- **n - Number of bars in layer** - input number of bars in individual layer (in direction perpendicular to the wall plane).
- **Distances** – input spacing between vertical and horizontal bars.
- **Number of layers** – input number of layers of vertical and horizontal reinforcement.
- **Length of bars** – input length of bars of vertical and horizontal reinforcement.
- **Material** – select material of the reinforcement bar. Click  to add new material to the project.
- **Bar anchorage type** - see **Longitudinal bar anchorage types**.
- **M - Master** – select patch load/support, to which the reinforcement cage is related.
- **First bar distance** – input distance between first reinforcement bar of the cage and the insert point of patch load/support.

Properties group **Diagonal reinforcement** – properties of diagonal reinforcement of cage:

- **Add diagonal reinforcement** – switch on/off application of diagonal reinforcement into the reinforcement cage.
- **Ø – Diameter** – input diameter of reinforcement bar.
- **Distances** – input spacing between diagonal bars.
- **Number of layers** – input number of diagonal bars.
- **Length of bars** – input length of diagonal bars.
- **Bar anchorage type** - see **Longitudinal bar anchorage types**.

## 6.6.8 Hanging around patch support/load

Hanging adds lifting anchor to selected patch support/load.

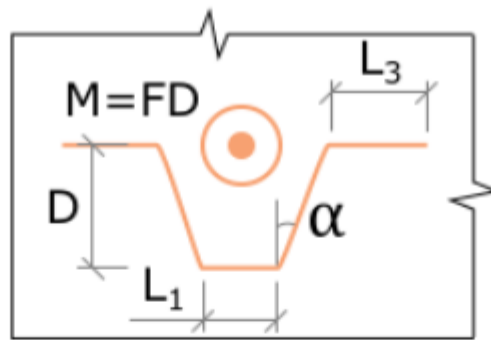

**Reinforcement**

Active	Name
<input checked="" type="checkbox"/>	ST1
<input checked="" type="checkbox"/>	GB1
<input checked="" type="checkbox"/>	GB2
<input checked="" type="checkbox"/>	GB3
<input checked="" type="checkbox"/>	IB1
> <input checked="" type="checkbox"/>	RD1

**Reinforcement**

$\Phi$  - Diameter [mm]

Material

Bar anchorage type

**Geometry**

D - Distance [mm]

L1 [mm]

L2 [mm]

L3 [mm]

$\alpha$  - Angle [°]

$\beta$  - Rotation [°]

Mirror reinforcement

M - Master

Mandrel diameter   $\Phi$

Properties group **Reinforcement**:

- $\emptyset$  – **Diameter** – input diameter of reinforcement bar.
- **Material** – select material of the reinforcement bar. Click to add new material to the project.
- **Bar anchorage type** - see [Longitudinal bar anchorage types](#).

Properties group **Geometry**:

- **D – distance** – input distance between a bottom branch of reinforcement and center of patch support/load.
- **L1 - L3** – input lengths of individual anchor branches.
- **$\alpha$**  – input angle between lifting anchor branches.
- **$\beta$**  – input angle of reinforcement rotation around patch support/load.
- **Mirror reinforcement** – switch on/off to generate the reinforcement mirrored around an axis passing the center of reinforcement and parallel to the bottom branch of reinforcement.
- **M – Master** – select patch support/load, to which is reinforcement related.
- **Mandrel diameter** - automatically determined mandrel diameter is displayed. Click  to edit the calculated value.

### 6.6.9 Wire fabrics

Wire fabric adds welded wire mesh into the discontinuity region of type Wall.

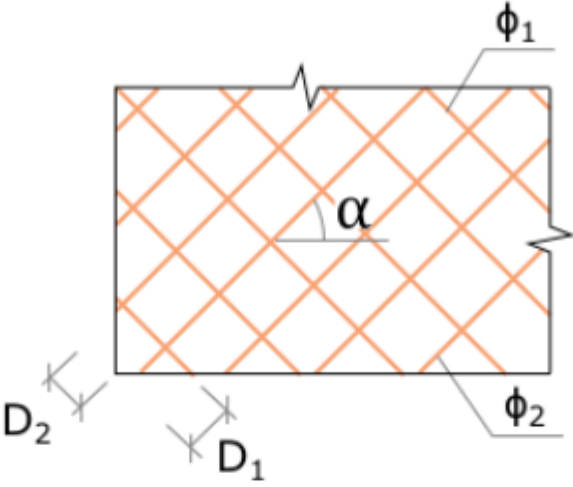

The diagram illustrates a rectangular wall section with a diagonal wire fabric mesh. The mesh is defined by diameters  $\phi_1$  and  $\phi_2$ , distances  $D_1$  and  $D_2$ , and an angle  $\alpha$ .

**Reinforcement** + - Copy Delete all Import DXF

Active	Name
<input checked="" type="checkbox"/>	WF1
<input checked="" type="checkbox"/>	GB1
<input checked="" type="checkbox"/>	GB2
<input checked="" type="checkbox"/>	GB3
<input checked="" type="checkbox"/>	GB4
<input checked="" type="checkbox"/>	IB1

**Wire fabric**

Diameters [mm]

Distances [mm]

Material  🔄

Number of fabrics

Concrete cover type

---

**Position**

Applied on

Position [mm]

Angle [°]

Separate by wall

---

**Patch load or support**

Related to patch load or support

Properties group **Wire fabric**:

- **∅ – Diameter** – input diameter of wire fabric bar. One value means identical diameters in both directions, two values mean different diameters in individual directions.
- **Distances** – input spacing between bars of wire fabric. One value means identical distances in both directions, two values mean different distances in individual directions.
- **Material** – select material of the wire fabric bar. Click 🔄 to add new material to the project.
- **Number of fabrics** – input number of parallel meshes in the related sub-region.

- **Concrete cover type** – select mode of cover definition:
  - **From Settings** – the concrete cover value is taken from the Settings associated with the master item.
  - **User value** – concrete cover is defined by user:
    - **Cover** – input value of concrete cover.

Properties group **Position**:

- **Applied on** – select the subregion, to which is the current wire fabric applied.
- **Position** – input position of wire mesh origin relative to the origin of the local coordinate system of the subregion. One value means offset in the x-axis direction, two values mean offsets in x-axis and z-axis directions.
- **Angle** – input inclination angle of bars of wire fabric.
- **Separate by wall** – if selected, the bars of wire fabric are not continuous over the edges of neighboring walls.







Properties group **Patch load or support**:

- **Interconnect automatically** – if selected, patch loads/supports adjacent to the reinforcement are found and connected to reinforcement so, that the reinforcement transfers load effects/reactions.



### 6.6.10 Longitudinal bar anchorage types

The anchoring length and forces are calculated respecting the selected anchorage type at the appropriate end of reinforcement bar. One of following anchorage types can be set for longitudinal reinforcement bar:

-  - reinforcement bar ended with standard straight anchoring length.
-  - reinforcement bar ended with a standard bend.
-  - reinforcement bar ended with a standard hook.
-  - reinforcement bar ended with loop.
-  - reinforcement bar ended with welded transversal bar.
-  - reinforcement bar considered to be with a perfect bond or continuous.

## 7 User defined templates

The existing discontinuity region can be stored in the database of user-defined templates or to the single template file. The stored template can be used to create new discontinuity region or to reinforce the existing discontinuity region.

Some sample files of exported templates may be installed by IDEA StatiCa installer (files \*.exp in the subdirectory \ExportedTemplates of IDEA StatiCa installation directory).

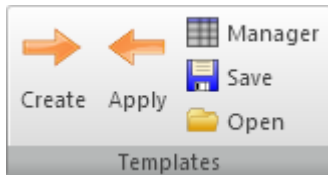

Commands in ribbon group **Templates** can be used to work with user templates:

- **Create** – stores the current discontinuity region into the database of user templates. Dialog **Add template** appears. The target folder must be selected in the tree control in the left part of the dialog. The current discontinuity region is stored as a template into the selected folder.
- **Apply** – creates new discontinuity region based on the selected template – see **Creating a discontinuity region from the user template** or applies reinforcement from the selected template on the current discontinuity region – see **Reinforcing a discontinuity region from the user template**.
- **Manager** – launches templates manager – see **Templates manager**.
- **Save** – stores the current discontinuity region into the single file.
- **Open** – this command is available:
  - In navigator command **Discontinuity region > Geometry**, if no geometry item is defined – new discontinuity region including loads and reinforcement is created from the selected file.
  - In navigator command **Discontinuity region > Reinforcement** – applies reinforcement from the selected file to the current discontinuity region.

## 7.1 Creating a discontinuity region from the user template

Discontinuity region can be created from the template in navigator **Discontinuity region > Geometry** if no geometry item exists.

Dialog **Apply template** appears after starting to create new discontinuity region from the template.

Select the required template in the tree of available templates. Click **Apply** to create the geometry, loads and reinforcement from the selected user template.

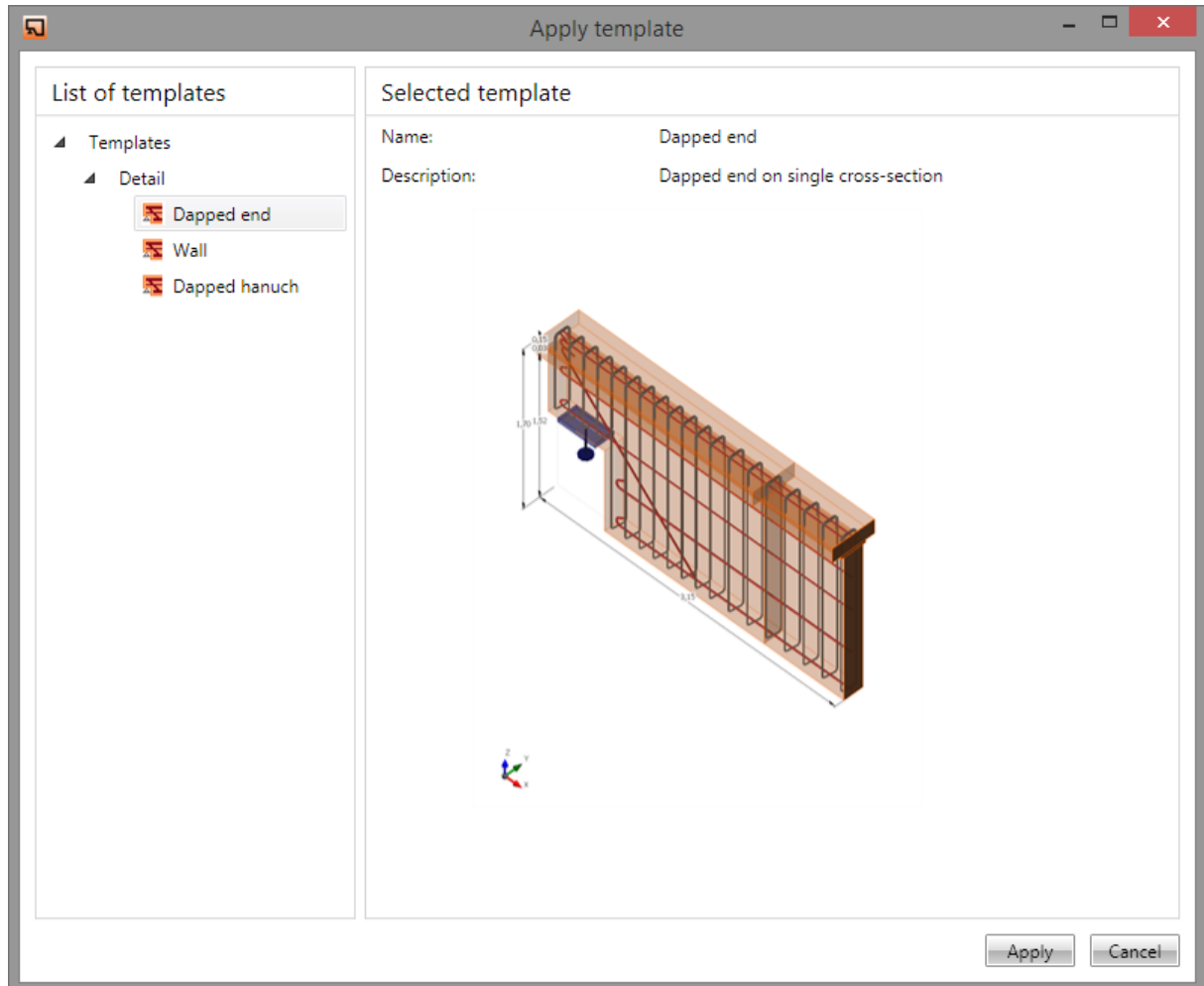

## 7.2 Reinforcing a discontinuity region from the user template

Discontinuity region can be reinforced using the template in navigator **Discontinuity region > Reinforcement**.

Dialog **Apply template** appears after starting to reinforce the current discontinuity region from the template.

Select the template containing the required reinforcement in the tree of available templates. Click **Apply** to reinforce the current discontinuity region by reinforcement from the template.

## 7.3 Templates manager

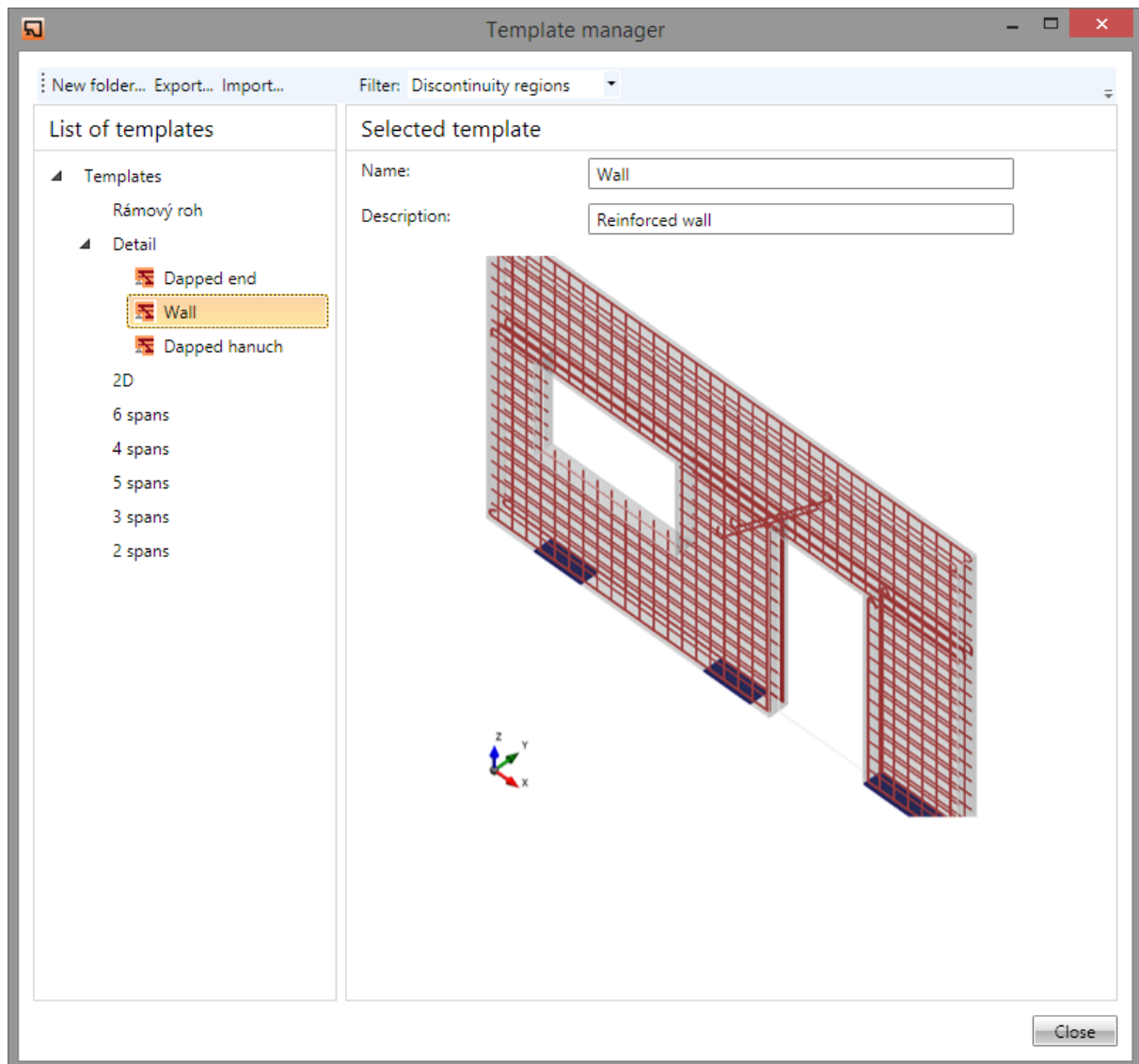

Templates manager is used to managing templates in the database. The templates database collects templates for:

- Reinforcement templates;
- Templates of tendon shapes;
- Templates of connection manufacturing operations;
- Templates of discontinuity regions;
- Templates of reinforcement of discontinuity region.

Template types to be displayed can be selected in the combo box **Filter**.

The templates are stored using the structure of folders and items in folders (similar to the structure of folders and files on the drive).

The database structure (with respect to the filter settings) is displayed in the left part of the dialog. Details of selected template or selected folder are displayed in the right part of the dialog.

Following actions can be performed in the templates manager:

- **Create new folder** – by command **New folder...** in the main menu to create a new folder in the root folder or in the current subfolder.
- **Rename folder** – by command **Edit** in the context menu by right mouse click on the required folder.
- **Move folder** – drag, and drop selected folder(s) to the required target folder.
- **Remove folder (s)** – by command **Delete** in the context menu by right mouse click above the selected folder (s). The folder is removed including all subfolders and all templates in removed folders and subfolders.
- **Edit template name and description** – template name and description of selected template are displayed in the right part of the dialog. The template name and description can be modified.
- **Move template** – drag and drop selected template(s) by the mouse to the required target folder.
- **Delete template(s)** – by command **Delete** in the context menu by right mouse click above the selected template.
- **Export templates** – by command **Export...** in the main menu. Selected templates are stored into the file with extension \*.EXP. Exported templates can be e.g. used on another computer.
- **Import templates** – by command **Import...** in the main menu. Templates from the selected file with extension \*.EXP are imported into the database of templates.

## 8 Check of discontinuity region

Click navigator command **Discontinuity region > Check** to perform the overall check of discontinuity region and detailed check of individual subregions, reinforcement, and other components.

For the trimmed end of member 1D subregion, the calculation results are not available at the distance of half of the cross-section height from the trimmed end.

3D view of results respecting the current evaluation settings is drawn in the Main window.

Table with overall results of individual checks is printed in the Detail window.

Tabs with results tables of individual checks are displayed in the Data window. Detailed courses of results are drawn for the selected table row.

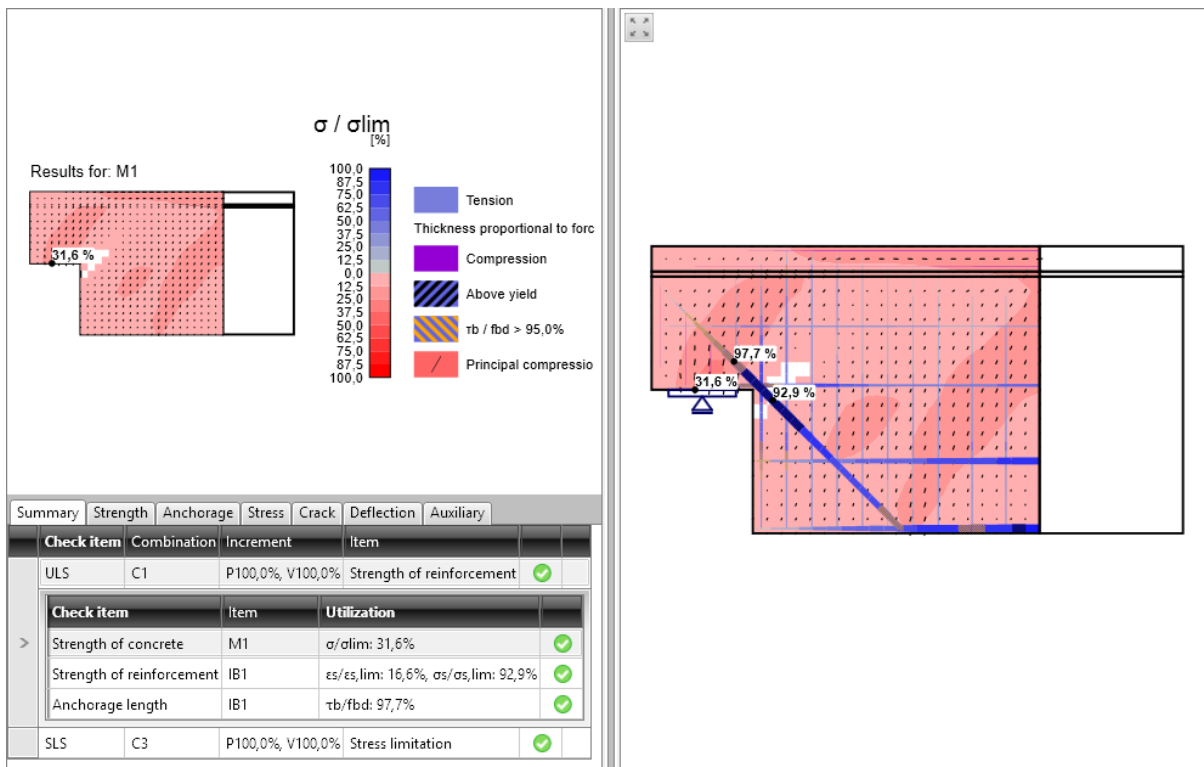

Ribbon groups **Results**, **Scale** and **Palette** are available when evaluating discontinuity region check results.

Each check can be evaluated on the separate tab in the Data window. Respecting the evaluation settings in ribbon group Results, the check results for the selected load case or extreme check values of the whole discontinuity region are printed.

Detailed drawing of corresponding discontinuity region item and the courses of results are drawn in the Data window for the current results table row.

## 8.1 Selecting the evaluated load case

Results are evaluated for the selected load case and the selected load increment.

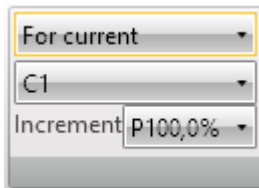

The evaluation mode is set in lists in the ribbon group Results:

- **For extreme** – the results evaluation is performed for that load case/combination, which causes the maximal value of check results.
- **For current** – the results evaluation is performed for the load case/combination selected in the list of analyzed load cases/combinations.
- **Increment** – the results evaluation is performed for the selected load increment.

## 8.2 Summary check results

Calculation status and overall statuses of individual checks or summary of loads and reactions in supports are printed on the tab **Summary**.

Calculation status and check results are evaluated for the reached load increment.

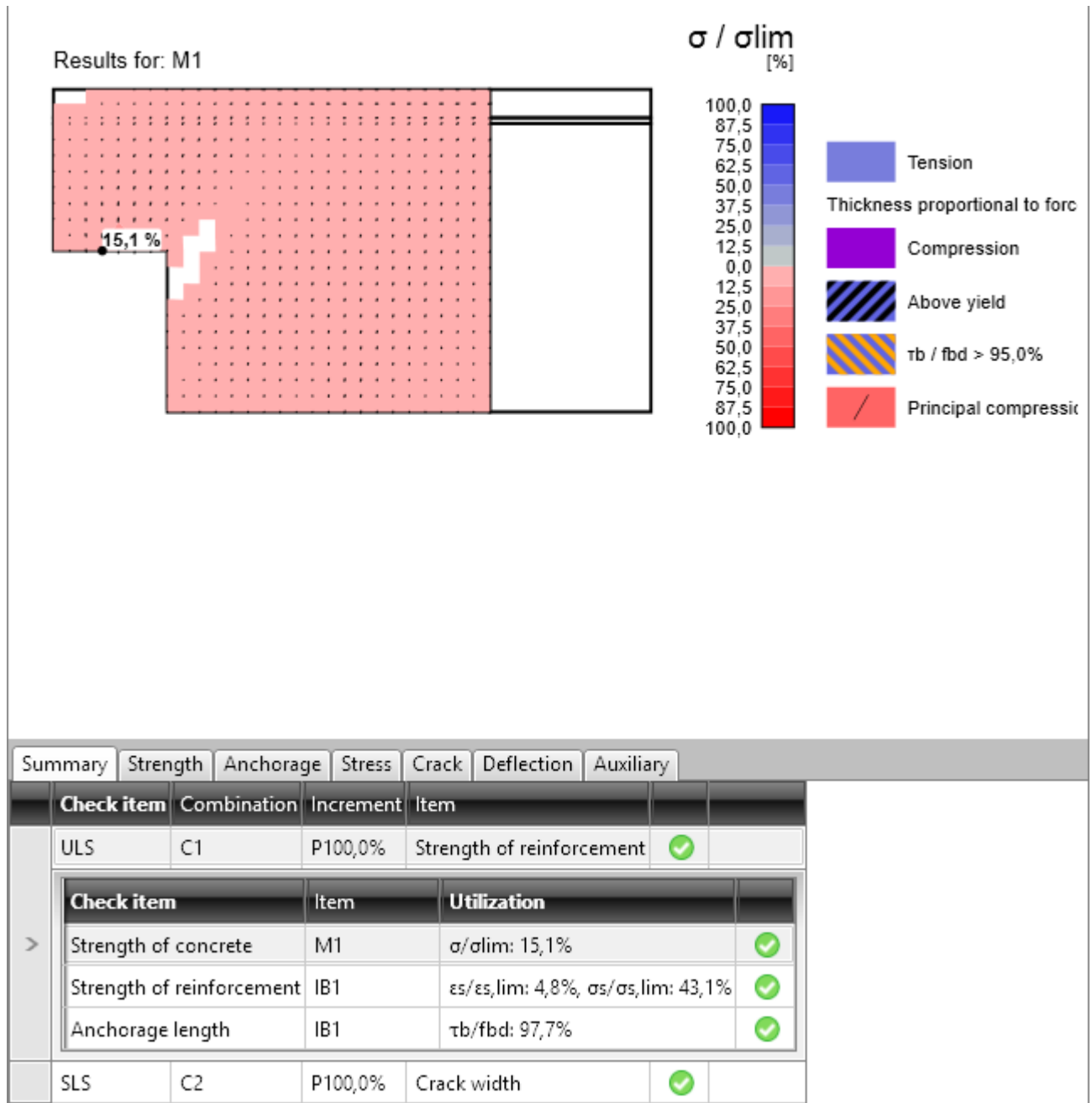

Summary check results of concrete and reinforcement for the selected or extreme load case can be evaluated on the tab **Summary**.

If the **ULS** table is selected, the results of ultimate limit state checks are printed in the table. The course of selected ULS check is drawn in the data window.

If the **SLS** table is selected, the results of serviceability limit state checks are printed in the table. The course of selected SLS check is drawn in the data window.

### 8.2.1 Drawing settings

If the tab **Summary** is selected, following results drawing can be set in the ribbon group **Results**:



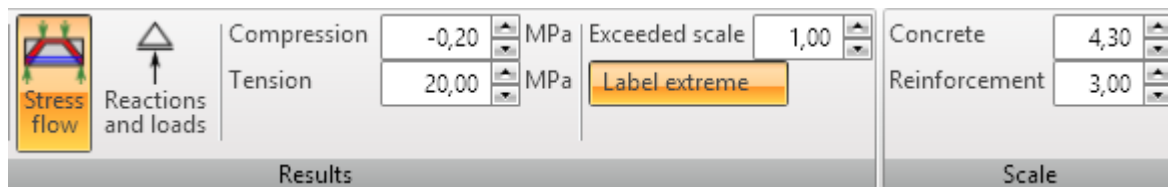

- **Stress-flow** – switch to draw areas of effective struts identified in the form of concrete compression zones and the ties displayed in the positions of reinforcement with line thickness proportional to the tensile stresses.
- **Reactions and loads** – if table of ULS results is selected on **Summary** tab, switches to draw the portion of the loads applied in current load case/combination, which can be resisted by the structure and corresponding support reactions.
- **Compression** – set the limit value to display the compressed area.
- **Tension** – set the limit value to display the tensioned area.
- **Exceeded scale** - set value of exceeded scale for drawing of cross-section.
- **Label extreme** - switch on/off drawing of extreme check result values.

Drawing scale of individual results can be set in the ribbon group **Scale**:

- **Concrete** – set the scale value for drawing of principal stresses directions.
- **Reinforcement** – set the scale value for drawing of results in reinforcement.

### 8.3 Strength check evaluation

Results of strength check of concrete and reinforcement for the selected or extreme load case can be evaluated on the tab **Strength**.

If the **Concrete** table is selected, the courses of an evaluated component of stress or strain in concrete for the whole discontinuity region are drawn in the Main window and for the item corresponding to a current row of the **Concrete** table are drawn in the Data window.

If the **Reinforcement** table is selected, the courses of an evaluated component of stress or strain reinforcement for the whole discontinuity region are drawn in the Main window and for the item corresponding to a current row of the **Reinforcement** table are drawn in the Data window.

Graphical evaluation of strength results can be set in the ribbon group **Results**.

### 8.3.1 Concrete strength check

Concrete strength check results can be evaluated in the **Concrete** table on the tab **Strength**.

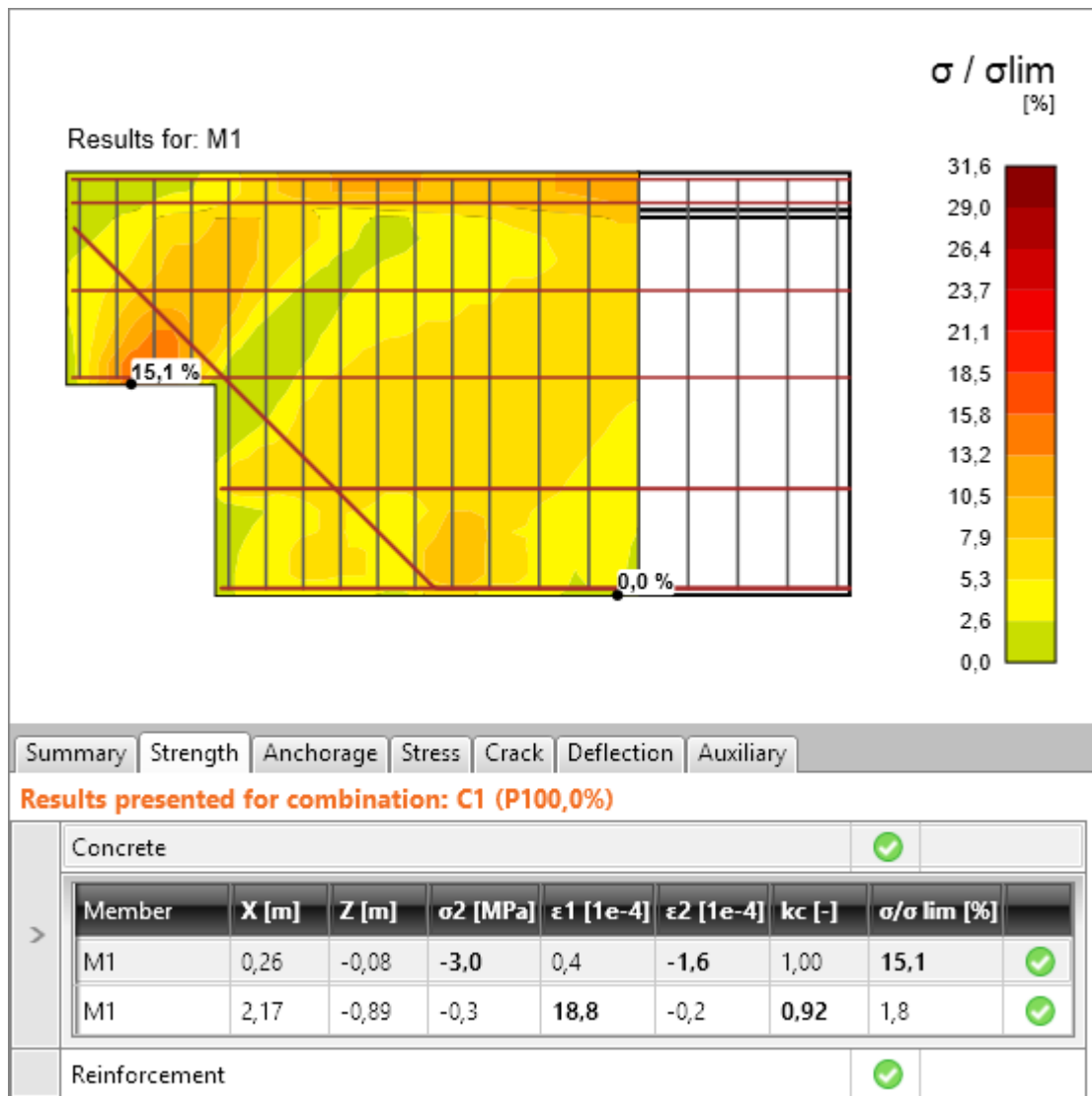

Columns in the **Concrete** table:

- **Member** – name of the evaluated subregion is printed.
- **X** -
- **Z** - distances of evaluated point from the GCS origin.
- **$\sigma_2$**  – the extreme value principal stress  $\sigma_2$  in concrete is printed.
- **$\epsilon_1$**  – value of maximal principal strain  $\epsilon_1$  is printed.
- **$\epsilon_2$**  – value of maximal principal strain  $\epsilon_2$  is printed.
- **kc** - value of concrete softening coefficient kc is printed.
- **$\sigma/\sigma_{lim}$**  – maximal utilization of concrete is printed – the ratio of calculated stress in concrete and concrete strength.

### 8.3.1.1 Drawing settings

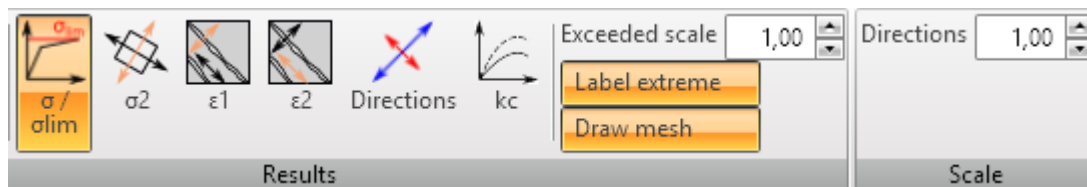

If the table **Concrete** on the **Strength** tab is active, drawing of following magnitudes can be set on the ribbon **Results**:

- **$\sigma/\sigma_{lim}$**  – switch to draw courses of main stress to concrete strength ratio – material utilization.
- **$\sigma_1$**  – switch to draw courses of main stress in concrete  $\sigma_1$ .
- **$\sigma_2$**  - switch to draw courses of main stress in concrete  $\sigma_2$ .
- **$\epsilon_1$**  - switch to draw courses of main strain in concrete  $\epsilon_1$ .
- **$\epsilon_2$**  - switch to draw courses of main strain in concrete  $\epsilon_2$ .
- **Directions** – switch to draw courses of main stresses in concrete.
- **kc** – switch to draw courses of concrete softening coefficient kc.
- **Exceeded scale** - set value of exceeded scale for drawing of cross-section.
- **Label extreme** - switch on/off drawing of check result values.
- **Draw mesh** - switch on/off drawing of finite elements mesh.

Ribbon group **Scale**:

- **Directions** - set the scale value for check directions drawing.

### 8.3.2 Reinforcement strength check

Reinforcement strength check results can be evaluated in the **Reinforcement** table on the tab **Strength**.

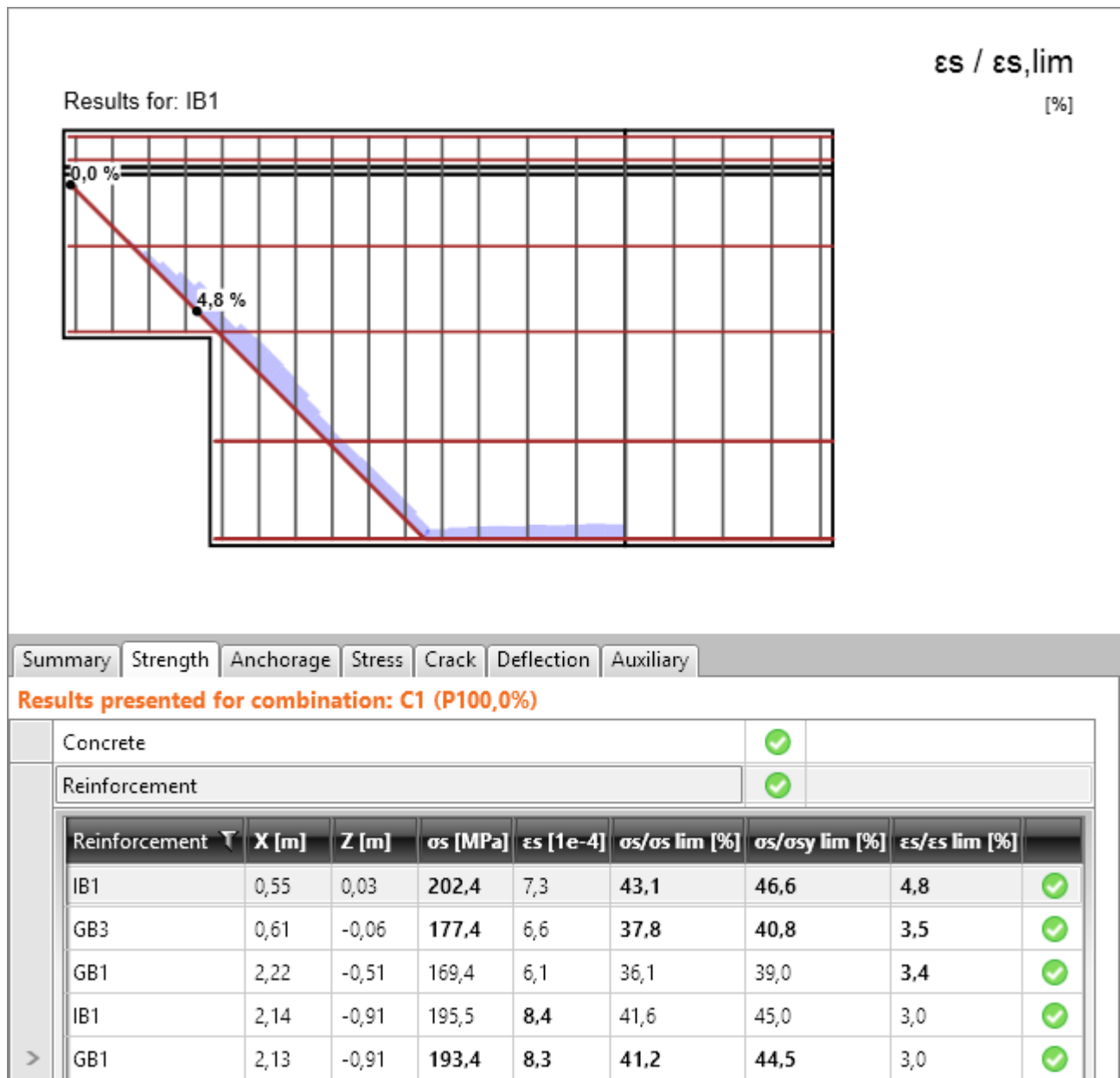

Columns in the **Reinforcement** table:

- **Reinforcement** – name of evaluated reinforcement is printed.
- **X** -
- **Z** - distances of evaluated point from the GCS origin.
- **$\sigma_s$**  – value of stress in reinforcement is printed.
- **$\epsilon_s$**  – value of strain in reinforcement is printed.
- **$\sigma_s/\sigma_{s,lim}$**  – value of maximal reinforcement utilization is printed – ratio of calculated stress in reinforcement and strength of reinforcement.
- **$\sigma_s/\sigma_{sy,lim}$**  – value of the ratio of calculated stress in reinforcement and yield strength of reinforcement is printed.

- **$\epsilon_s / \epsilon_{slim}$**  – value of the ratio of calculated strain in reinforcement and limit strain of reinforcement is printed.

### 8.3.2.1 Drawing settings



If the table **Reinforcement** on **Strength** tab is active, drawing of following magnitudes can be set on ribbon **Results**:

- **$\epsilon_s / \epsilon_{slim}$**  – switch to draw courses of the ratio of calculated strain in reinforcement and limit strain of reinforcement.
- **$\sigma_s / \sigma_{slim}$**  – switch to draw courses of reinforcement utilization – ratio of calculated stress in reinforcement and strength of reinforcement.
- **$\sigma_s / \sigma_{yield}$**  – switch to draw courses of the ratio of calculated stress in reinforcement and yield strength of reinforcement.
- **$\sigma_s$**  – switch to draw courses of stress in reinforcement.
- **$\epsilon_s$**  – switch to draw courses of strain in reinforcement.
- **Exceeded scale** - set value of exceeded scale for drawing of cross-section.
- **Label extreme** - switch on/off drawing of check result values:
  - **Group** – switch to draw numerical values of a maximum of evaluated magnitude for the extreme bar in the current group only.
  - **Bar** – switch to draw numerical values of a maximum of evaluated magnitude for each bar in the current group.

Ribbon group **Scale**:

- **Reinforcement** – set the scale value for drawing of results in reinforcement.

## 8.4 Reinforcement anchorage check

Results of anchorage check for the selected or extreme load case can be evaluated on the tab **Anchorage**.

The courses of anchorage check for the whole discontinuity region are drawn in the Main window.

Table of anchorage check results for each defined reinforcement group is printed in the Data window. Detailed course of check result is drawn for the current row of the results table.

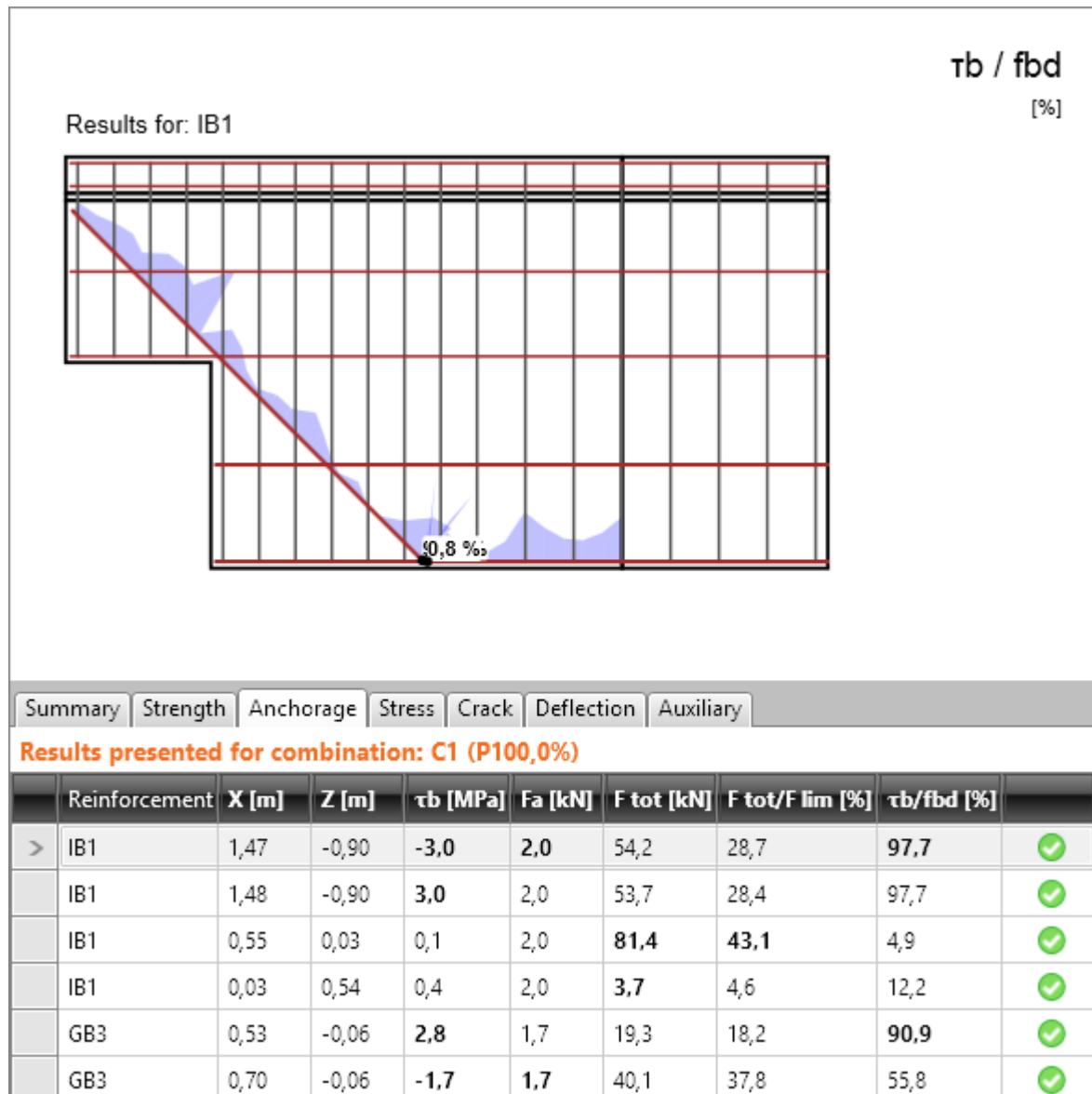

Columns in the table:

- **Reinforcement** – name of evaluated reinforcement is printed.
- **X** -
- **Z** - distances of evaluated point from the GCS origin.
- **$\tau_b$**  – calculated value of bond stress on reinforcement bar surface is printed.
- **Fa** – value of anchorage force at the ends of bars due to anchorage type is printed.
- **Ftot** – value of total force along the bar is printed. The force consists of anchorage force and bond force, which integrates the bond stress on the bar surface.

- **Ftot/Flim** – ratio of total force and limit force is printed. The limit value of the force is calculated as the minimum of two values: (a) the force calculated as the sum of ultimate anchorage force and the force developed from the end of the bar to the point of interest assuming ultimate bond strength, (b) the ultimate strength of the bar.
- **τb/fbd** – ratio of bond stress and limit bond strength is printed. It shows the level of utilization with respect to ultimate bond strength between the rebar and adjacent concrete.

### 8.4.1 Drawing settings

If the **Anchorage** tab is active, drawing of following magnitudes along bars can be set on ribbon **Results**:

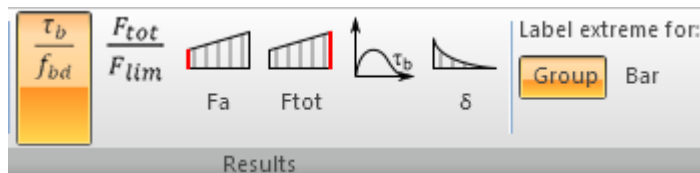

- **τb/fbd** – switch to draw courses of the ratio of bond stress and limit bond strength.
- **Ftot/Flim** – switch to draw courses of the ratio of total force and limit force.
- **Fa** – switch to draw courses of anchorage force at the ends of bars.
- **Ftot** – switch to draw courses of the total force.
- **τb** – switch to draw courses of bond stress on reinforcement bar surface.
- **δ** – switch to draw courses of relative displacement value of the bar surface and adjacent concrete.
- **Group** – switch to draw numerical values of a maximum of evaluated magnitude for the extreme bar in the current group only.
- **Bar** – switch to draw numerical values of a maximum of evaluated magnitude for each bar in the current group.



## 8.5 Stress limitation check evaluation

Results of stress limitation check of concrete and reinforcement for the selected or extreme load case can be evaluated on the tab **Stress**.

If the **Concrete** table is selected, the course of concrete stress limitation check for the whole discontinuity region is drawn in the Main window and for the item corresponding to a current row of the **Concrete** table is drawn in the Data window.

If the **Reinforcement** table is selected, the courses of reinforcement stress limitation check for the whole discontinuity region are drawn in the Main window and for the item corresponding to a current row of the **Reinforcement** table are drawn in the Data window.

Graphical evaluation of stress limitation check can be set in the ribbon group **Results**.

### 8.5.1 Concrete stress limitation check

Concrete stress limitation check results can be evaluated in the **Concrete** table on the tab **Stress**.

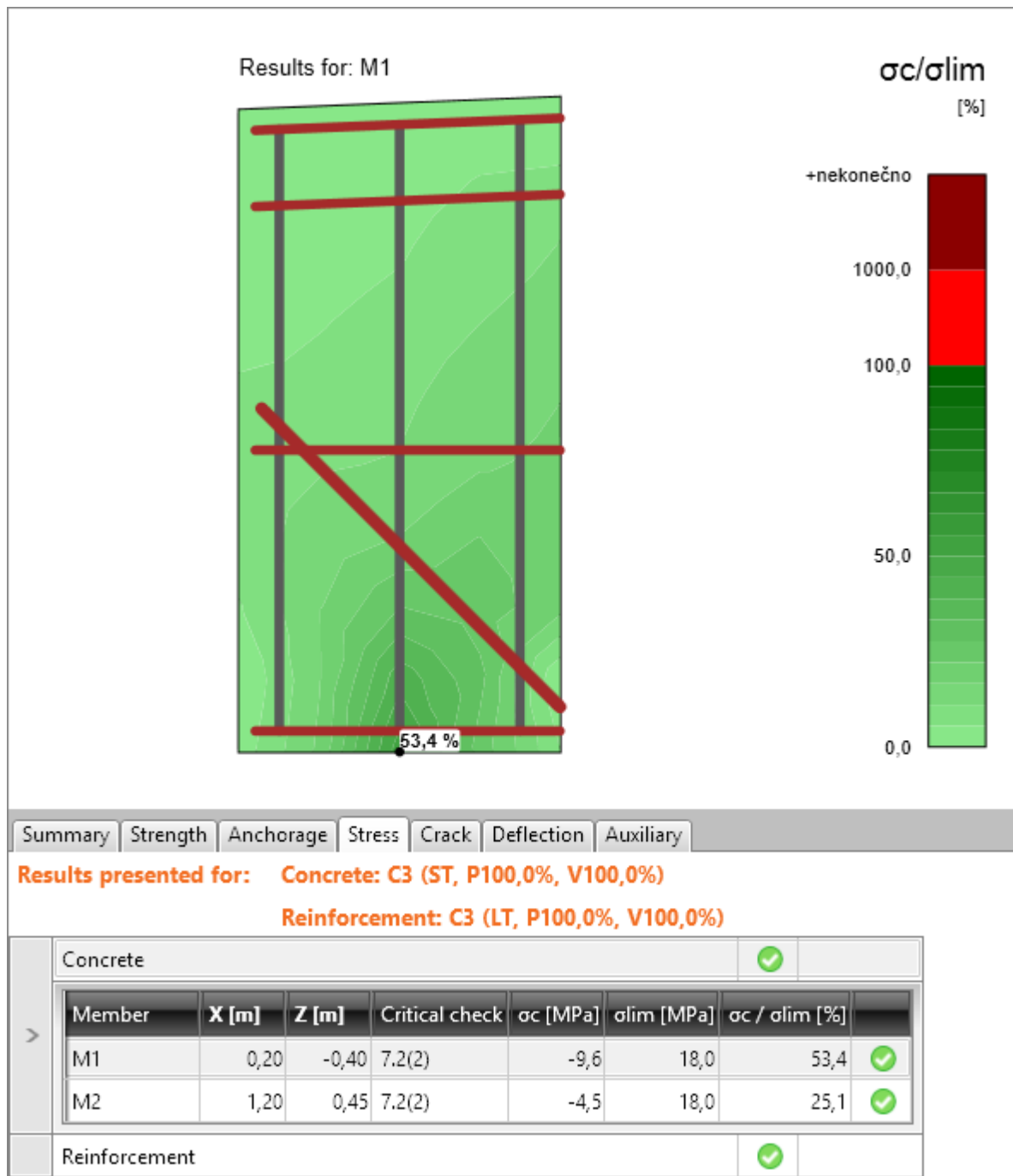

Columns in the **Concrete** table:

- **Member** – name of the evaluated subregion is printed.
- **X** -
- **Z** - distances of evaluated point from the GCS origin.
- **Critical check** – the article, according to which the check value was determined, is printed.
- **$\sigma_c$**  – the calculated value of stress in concrete is printed.
- **$\sigma_{lim}$**  – the limit value of stress in concrete is printed.

- $\sigma/\sigma_{lim}$  – maximal utilization of concrete is printed – the ratio of calculated stress in concrete and limit stress.

### 8.5.1.1 Drawing settings

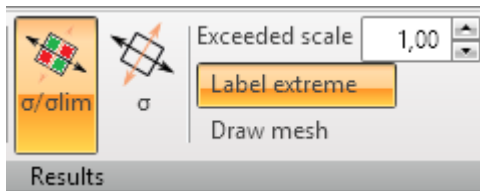

If the table **Concrete** on the **Stress** tab is active, drawing of following magnitudes can be set on the ribbon **Results**:

- $\sigma/\sigma_{lim}$  – switch to draw courses of calculated stress in concrete to limit concrete stress ratio – material utilization.
- $\sigma$  – switch to draw courses of stress in concrete.
- **Exceeded scale** - set value of exceeded scale for drawing of cross-section.
- **Label extreme** - switch on/off drawing of check result values.
- **Draw mesh** - switch on/off drawing of finite elements mesh.

## 8.5.2 Reinforcement stress limitation check

Reinforcement stress limitation check results can be evaluated in the **Reinforcement** table on the tab **Stress**.



Columns in the **Reinforcement** table:

- **Reinforcement** – name of evaluated reinforcement is printed.
- **X** -
- **Z** - distances of evaluated point from the GCS origin.

- **Critical check** – the article, according to which the check value was determined, is printed.
- **$\sigma_s$**  – the calculated value of stress in reinforcement is printed.
- **$\sigma_{lim}$**  – the limit value of stress in reinforcement is printed.
- **$\sigma_s/\sigma_{lim}$**  – maximal utilization of reinforcement is printed – the ratio of calculated stress in reinforcement and limit stress.

### 8.5.2.1 Drawing settings



If the table **Reinforcement** on **Stress** tab is active, drawing of following magnitudes can be set on ribbon **Results**:

- **$\sigma/\sigma_{lim}$**  – switch to draw courses of calculated stress in reinforcement to limit reinforcement stress ratio – material utilization.
- **$\sigma$**  – switch to draw courses of stress in reinforcement.
- **Exceeded scale** - set value of exceeded scale for drawing of cross-section.
- **Label extreme** - switch on/off drawing of check result values:
  - **Group** – switch to draw numerical values of a maximum of evaluated magnitude for the extreme bar in the current group only.
  - **Bar** – switch to draw numerical values of a maximum of evaluated magnitude for each bar in the current group.

Ribbon group **Scale**:

- **Reinforcement** – set the scale value for drawing of results in reinforcement.

## 8.6 Crack width check

Results of crack width check for the selected or extreme load case can be evaluated on the tab **Crack**.

The crack width is checked in the vicinity of the reinforcement only. No control of cracking is performed in non-reinforced zones. The calculation model may lead to underestimations of the crack width in case of localized shear cracks and cracks in corners with opening moments.

The courses of crack width check for the whole discontinuity region are drawn in the Main window.

Table of extremal crack width check results is printed in the Data window. Detailed course of crack width is drawn for the current row of the results table.

Ribbon groups **Crack width** and **Model** are available.

Graphical evaluation of crack width check can be set in the ribbon group **Results**.

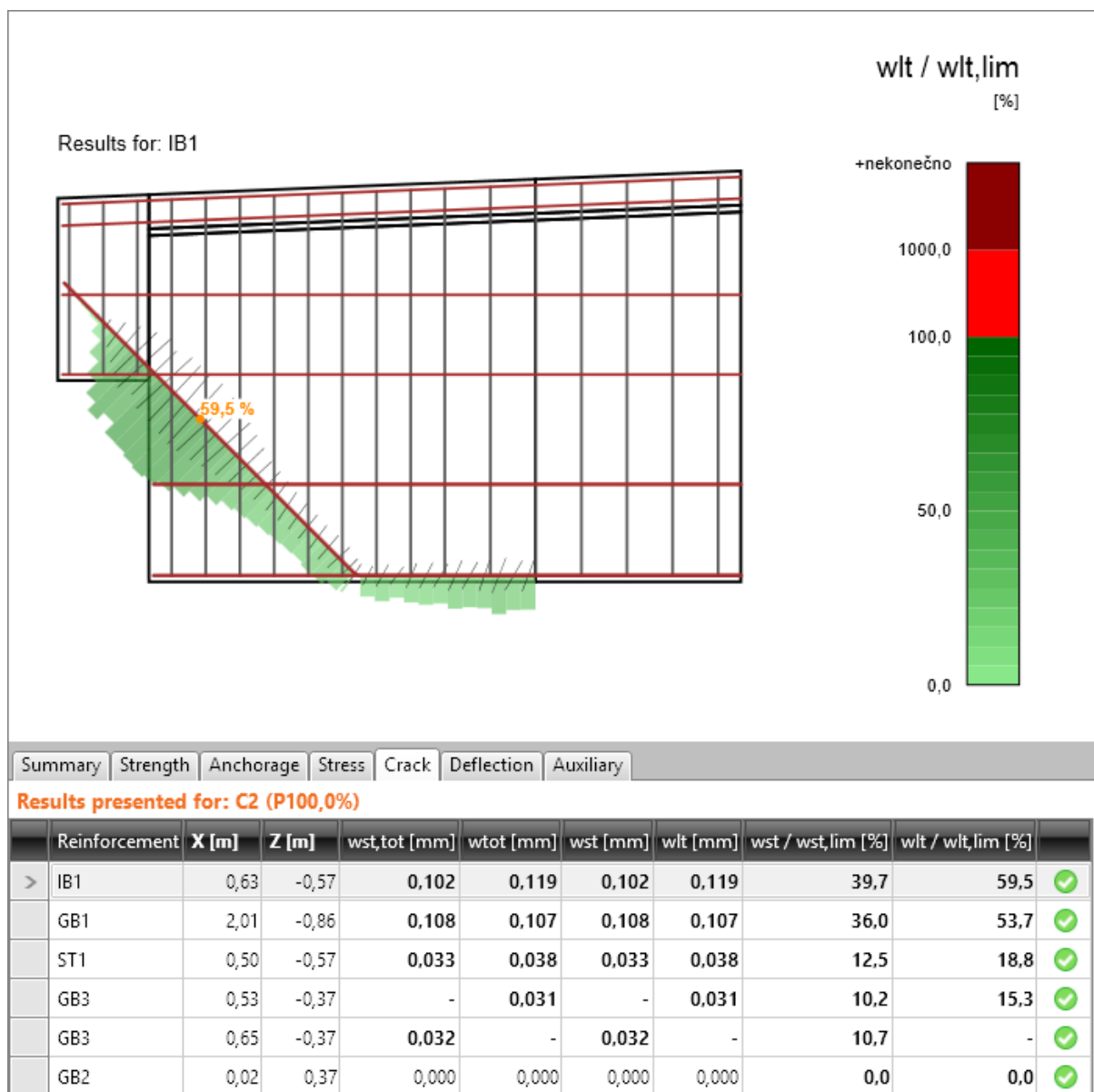

Columns in the table:

- **Reinforcement** – name of evaluated reinforcement is printed.
- **X** -

- **Z** - distances of evaluated point from the GCS origin.
- **wst, tot** - short-term crack width (calculated with secant modulus of elasticity  $E_{cm}$  with total loads) is printed.
- **wtot** - long-term crack width (calculated with effective modulus of elasticity  $E_{eff}$  with total permanent loads).
- **wst** - short-term crack width (calculated with secant modulus of elasticity  $E_{cm}$  with permanent loads) is printed.
- **wlt** - long-term crack width (calculated with effective modulus of elasticity  $E_{eff}$  with permanent loads) is printed.
- **wst/wst, lim** - the ratio of short-term crack width to limit short-term crack width is printed.
- **wlt/wlt, lim** - the ratio of long-term crack width to limit long-term crack width is printed.

### 8.6.1 Ribbon group Crack width

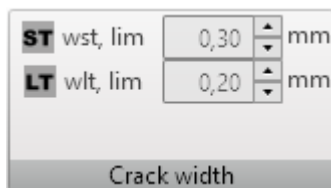

- **ST wst,lim** - switch on/off execution of short-term crack width check. The calculated width of short-term crack is compared to the specified limit crack width.
- **LT wlt,lim** - switch on/off execution of long-term crack width check. The calculated width of long-term crack is compared to the specified limit crack width.

### 8.6.2 Ribbon group Model

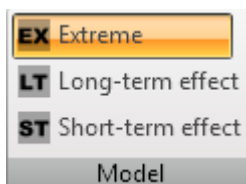

- **Extreme** - switch to evaluate crack width for the most extremal calculation model
- **Long-term effect** - switch to evaluate crack width for long-term effects calculation model.
- **Short-term effect** - switch to evaluate crack width for short-term effects calculation model.

### 8.6.3 Drawing settings

If the tab **Crack width** is selected, following results drawing can be set in the ribbon group **Results**:



- **w/wlim** – switch to draw courses of extremal ratio of calculated crack width to limit crack width .
- **w** – switch to draw courses of calculated crack width for the selected calculation model .
- **Exceeded scale** - set value of exceeded scale for drawing of cross-section.
- **Label extreme** - switch on/off drawing of check result values:
  - **Group** – switch to draw numerical values of a maximum of evaluated magnitude for the extreme bar in the current group only.
  - **Bar** – switch to draw numerical values of a maximum of evaluated magnitude for each bar in the current group.

Ribbon group **Scale**:

- **Crack width** – set the scale value for drawing of crack width.



## 8.7 Deflection calculation

Results of deflection calculation for the selected or extreme load case can be evaluated on the tab **Deflection**.

The courses of deflections for the whole discontinuity region are drawn in the Main window.

Table of extremal deflections is printed in the Data window. Detailed course of deflection is drawn for the current row of the results table.

Graphical evaluation of deflection calculation can be set in the ribbon group **Results**.

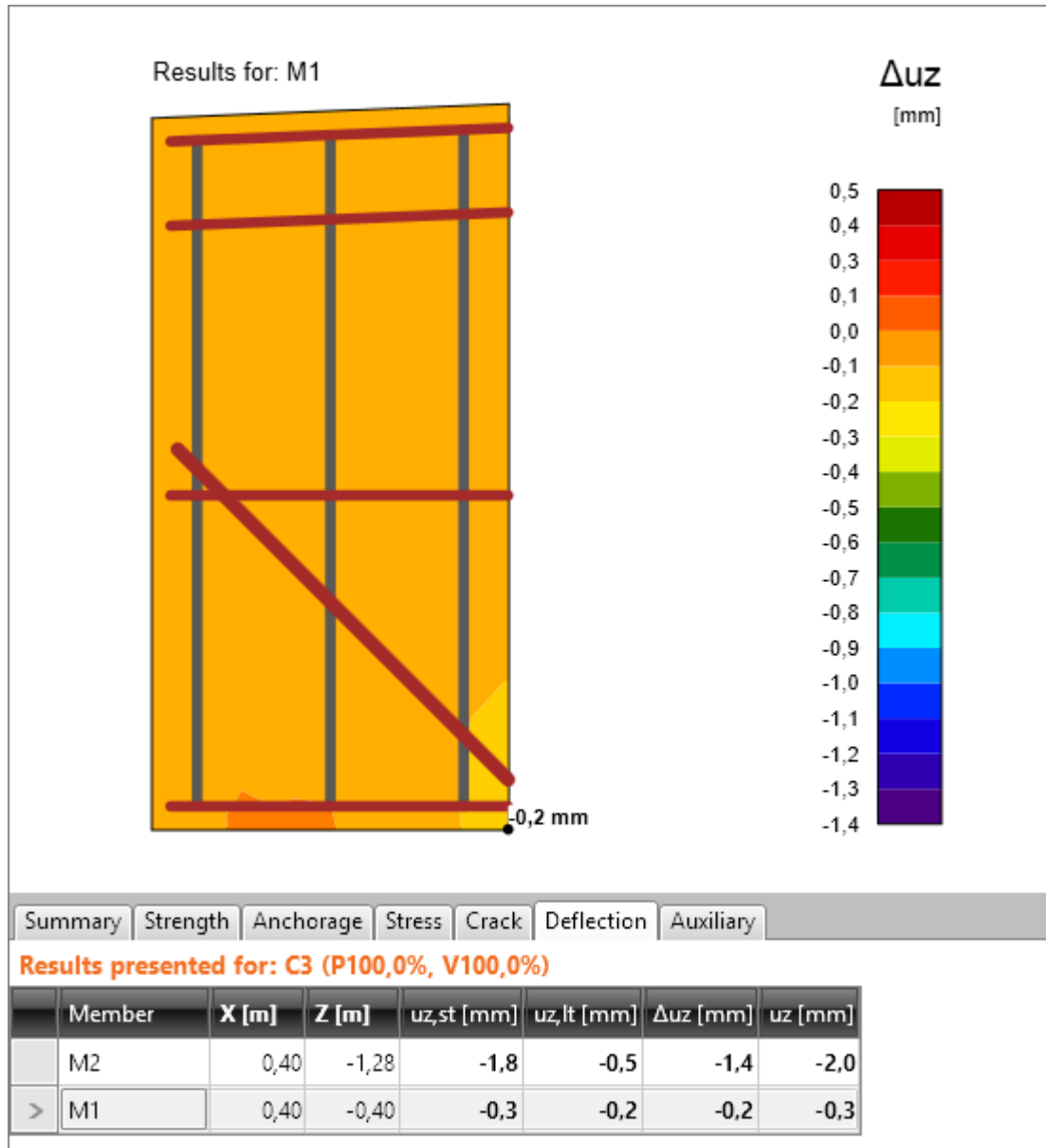

Columns in the table:

- **Member** – name of evaluated member is printed.
- **X** -
- **Z** - distances of evaluated point from the GCS origin.
- **uz, st** - the immediate deflection caused by total load (calculated for short-time stiffness) is printed.

- **uz, It** - the long-term deflection caused by long-term load is printed.
- **$\Delta uz$**  - deflection increment caused by variable loads for selected combination is printed.
- **uz** - total deflection including effect of creep is printed.

### 8.7.1 Drawing settings

If the tab **Deflection** is selected, following results drawing can be set in the ribbon group **Results**:

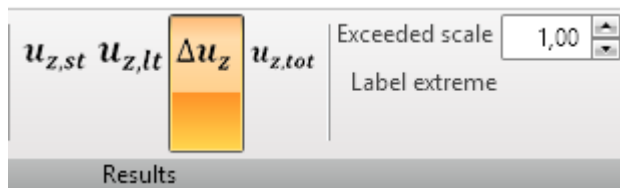

- **uz, st** - switch to draw courses of the immediate deflection caused by total load (calculated for short-time stiffness).
- **uz, lt** - switch to draw courses of the long-term deflection caused by long-term load.
- **$\Delta u_z$**  - switch to draw courses of deflection increment caused by variable loads.
- **uz** - switch to draw courses of total deflection including effect of creep.
- **Exceeded scale** - set value of exceeded scale for drawing of cross-section.
- **Label extreme** - switch on/off drawing of check result values.

## 8.8 Auxiliary results

Auxiliary results for the selected or extreme load case can be evaluated on the tab **Auxiliary**.

Deformations or tensile strain results are drawn in the Main window.

Tables of auxiliary results are printed in the Data window.

### 8.8.1 Tensile strain evaluation

To evaluate tensile strain results click **Tensile strain** in ribbon group **Results**.

Summary Strength Anchorage **Auxiliary**

**Results presented for load case: LC1, Load increment: 100,0%**

	Member	$\epsilon_1 [1e-4]$	X [m]	Z [m]
>	M1	2,2	0,35	-0,35
	M2	8,2	0,44	-0,45

**Achievement of numerical convergence criteria**

	Check item	$\epsilon/\epsilon_{lim} [\%]$	$\sigma/\sigma_{lim} [\%]$	Item	
>	Concrete in compression	0,3	15,2	M1	✓
	Concrete in tension	1,2	0,0	M2	✓
	Reinforcement	2,6	31,4	IB1	✓
	Anchorage length	0,5	99,8	IB1	✓

The results given on this screen are informative only and cannot be considered as code checks of crack width.

Minimum amount of reinforcement resisting at least the tensile stresses prior cracking has to be provided in cracked zones.

Columns in strain table:

- **Member** – name of subregion is printed.
- **$\epsilon_1$**  – value of maximal principal strain is printed.
- **X** – X-axis GCS coordinate of the point, where the maximal strain was reached, is printed.
- **Z** – Z-axis GCS coordinate of the point, where the maximal strain was reached, is printed.

Columns in table **Achievement of numerical convergence criteria**:

- **Check item** – name of the check is printed.
- **$\epsilon/\epsilon_{lim}$**  – maximal utilization of material from the point of view of strain is printed – ratio of calculated strain to the limit strain.
- **$\sigma/\sigma_{lim}$**  – maximal utilization of material from the point of view of strength is printed – ratio of calculated stress to the limit stress.
- **Item** – name of the corresponding subregion is printed.

### 8.8.2 Evaluation of deformations

To evaluate deformations results click **Deformations** in ribbon group **Results**.

Summary Strength Anchorage Auxiliary					
<b>Results presented for load case: LC1, Load increment: 100,0%</b>					
	Member	Min/max	Displacement [mm]	X [m]	Z [m]
>	M2	Maximum	0,6	2,01	-1,28
	M1	Minimum	0,0	0,20	-0,40

Columns in the table of deformations:

- **Member** – name of the subregion is printed.
- **Min/max** –type of extreme is printed.
- **Displacement** – maximal value of displacement is printed.
- **X** – X-axis GCS coordinate of the point, where the maximal displacement was reached, is printed.
- **Z** – Z-axis GCS coordinate of the point, where the maximal displacement was reached, is printed.

### 8.8.2.1 Drawing setting

If tab **Auxiliary** is active and command **Deformation** in ribbon group **Results** is selected, drawing of following results can be set in ribbon group **Results**:

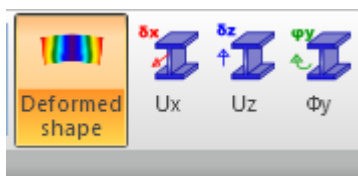

- **Deformed shape** – switch to draw the deformed shape of discontinuity region.
- **Ux** – switch to draw isobands of deformations in direction of global X-axis.
- **Uz** – switch to draw isobands of deformations in direction of global Z-axis.
- **Fiy** – switch to draw isobands of rotations about global Y-axis.

## 8.9 Bill of material

To generate a bill of material for the current discontinuity region click navigator command **Discontinuity region > Bill of material**.

Generated bill of material is displayed in the Main window.

## 8.10 Code and calculation settings

To change the code and calculation settings click **Settings** in ribbon group **Calculation**.

Analysis and checks	
Stop at limit strain	<input checked="" type="checkbox"/>
Number of increments (permanent part)	1
Number of increments (variable part)	1
Topology optimization	
Calculated volume levels	4
Minimal effective volume [-]	0,2
Material factors	
$\gamma_c$	1,5
$\gamma_s$	1,15
$\alpha_{cc}$	1
$\epsilon_{ud}/\epsilon_{uk}$	0,9
Detailing rules	
8.3(2) $\Phi_{m,min}$	
$\Phi_{m,min} - \Phi_s \leq 16\text{mm}$ (Multiple of diameter $\Phi_s$ )	4
$\Phi_{m,min} - \Phi_s > 16\text{mm}$ (Multiple of diameter $\Phi_s$ )	7

Buttons: Expand, Collapse, OK, Cancel

Properties group **Analysis and checks**:

- **Stop at limit strain** – if selected, the iterative calculation is terminated after the limit strain is reached in the discontinuity region.
- **Number of increments (permanent part)** – select the number of increments, to which is the load defined in permanent load cases divided for iterative analysis.
- **Number of increments (variable part)** – select the number of increments, to which is the load defined in variable load cases divided for iterative analysis.

Properties group **Topology optimisation**:

- **Calculated volume levels** – input number of effective volume levels, for which the topology optimisation is calculated.
- **Minimal volume level** – input minimal volume part, which is expected to be effective for transfer of loads.

Properties group **Material factors**:

- **$\gamma_c$**  – partial safety factor for resistance of concrete.
- **$\gamma_s$**  – partial safety factor for resistance of steel.
- **$\alpha_{cc}$**  – coefficient taking into account the long-term effect on the compressive strength and the

unfavourable from the way the load is applied

- $\epsilon_{ud}/\epsilon_{uk}$  – ratio of design and characteristic strain limit.

Properties group **Detailing rules:**

- $\emptyset_{m, \min} - \emptyset_s \leq 16 \text{ mm}$  – minimal mandrel diameter of stirrup as a multiple of stirrup diameter.
- $\emptyset_{m, \min} - \emptyset_s > 16 \text{ mm}$  – minimal mandrel diameter of stirrup as a multiple of stirrup diameter.



## 9 Project summary

### 9.1 Discontinuity regions in project

The project can contain more discontinuity regions. Click navigator command **Project > Discontinuity regions** to display list of defined discontinuity regions.

Table of all defined discontinuity regions is displayed in the main window. The current discontinuity region is drawn in the 3D window.

Ribbon group **New discontinuity region** is displayed.

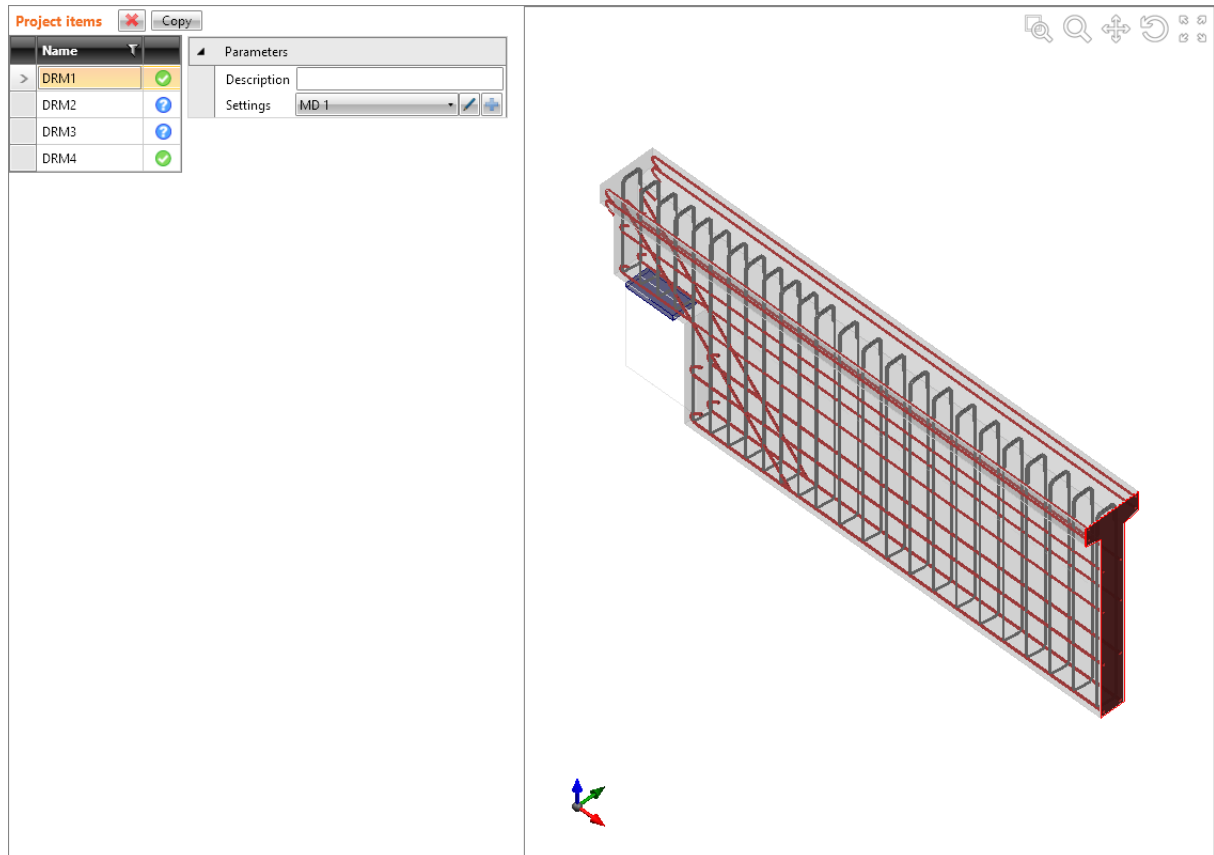



Commands above table **Project items**:

- - delete the current discontinuity region from project.
- **Copy** – add new discontinuity region into the project by copying the current discontinuity region.

Columns in **Project items** table:

- **Name** – input name of discontinuity region. Change of the name is respected in the combo box in top of the navigator.
- **Status** – icon indicates check status of the discontinuity region.

Properties group **Parameters**:

- **Description** – input description of the current region.
- **Settings** – select or modify Settings of the current discontinuity region.
  -  - launch modification of the current Settings.
  -  - add new Settings into the project.
- **Report** - add or modify user defined paragraph to be printed in report in the current discontinuity region chapter.

### 9.1.1 Project data

Click navigator command **Project summary > Project data** to display the table of basic and identification project data

Project parameters	
Code	EN
Identification	
Name	<input type="text"/>
Number	<input type="text"/>
Author	<input type="text"/>
Description	<input type="text"/>
Date	27. 4. 2018
Report	<input type="text" value="You can add text and pictures"/> 

- **Name** – input of the project name.
- **Number** – input of the project identification number.
- **Author** – input name of the project author name.
- **Description** – input of additional information about the structure.
- **Date** – date of calculation.
- **Report** – input user defined paragraph, which will be printed in the chapter **Project data** of the report – see [User defined paragraph editor](#)

### 9.1.2 Adding discontinuity region into the project

New discontinuity region can be added into the project by following ways:

- Anytime clicking  beside the list of discontinuity regions in navigator. It launches **Discontinuity region wizard** – see [New project](#).
- Using commands in ribbon group **New discontinuity region** in navigator **Project summary > Discontinuity regions** - see [Ribbon group New discontinuity region](#).

### 9.1.3 Ribbon group New discontinuity region

Commands in ribbon group **New discontinuity region** are used to add new discontinuity region to project:



- **Members 1D** – displays dialog **Select topology of discontinuity region** with predefined 1D details. The new discontinuity region is added into the project after clicking the picture of required topology.
- **Walls** – displays dialog **Select topology of discontinuity region** with predefined details of walls. The new discontinuity region is added into the project after clicking the picture of required topology..
- **Diaphragms** – displays dialog **Select topology of discontinuity region** with predefined diaphragms details. The new discontinuity region is added into the project after clicking the picture of required topology.
- **General** – adds a new empty discontinuity region into the project – the discontinuity region does not contain any member subregion.

## 9.2 Preview and print of calculation report

Input data, calculation results and check results can be printed in the output report. The report can contain texts, tables, and pictures. Structure of protocol is fixed, it is only possible to set, which tables and which pictures should be generated.

To generate the report click navigator command **Project summary > Report preview/Print**.

Ribbon groups **Report view**, **Type of report** and **Items in report** are available when working with the report.

### 9.2.1 Ribbon group Items in report

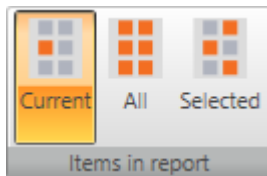

Report generation mode settings:

- **Current** – only data of current joint are printed to report.
- **All** – data of all joints in the project are printed to report.
- **Selected** – data of joints with the **Selected** option set to on are printed to report.

### 9.2.2 Ribbon group Type of report

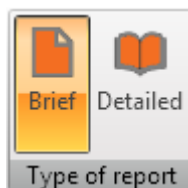

Report range settings:

- **Brief** – brief summary report for all (selected) project items is generated.
- **Detailed** – detailed report is generated for each (selected) project item.

### 9.2.3 Brief report

To generate brief report click navigator command **Project summary > Report Preview/Print** and select **Brief** in ribbon group **Type of report**.

The content of brief report can be set in the Data window.

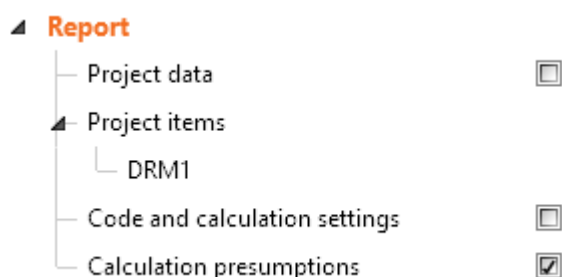

The brief report contains a picture of discontinuity region and a table of overall check results.

Options to set the content of brief report:

- **Project data** – switch on/off the print of project data table.
- **Project items** – according to the current settings of **Items in report** individual discontinuity regions can be switched on/off to be printed into the report.
- **Code and calculation settings** – switch on/off the print of code and calculation settings table.
- **Calculation presumptions** – switch on/off the print of calculation presumptions paragraph.

## 9.2.4 Detailed report

To generate brief report click navigator command **Project summary > Report Preview/Print** and select **Detailed** in ribbon group **Type of report**.

The content of detailed report can be set in the Data window.

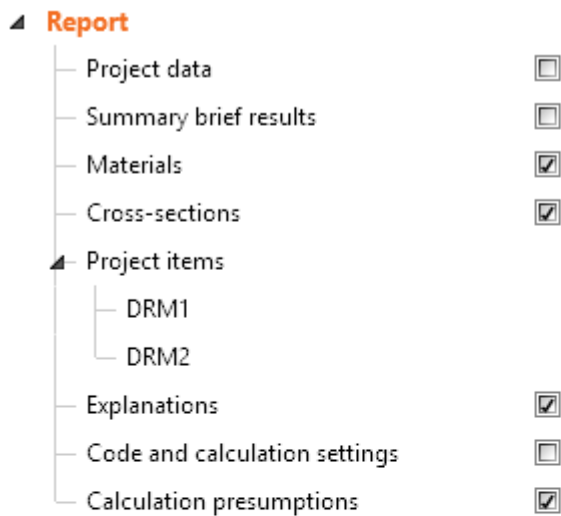

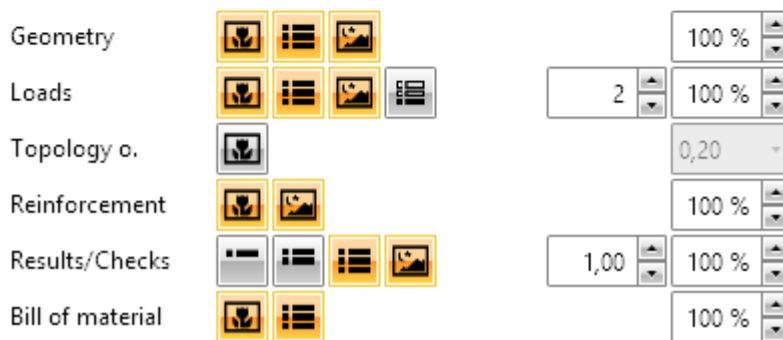

### Project items settings







Options to set the content of detailed report:

- **Project data** – switch on/off the print of project data table.
- **Summary brief results** – switch on/off the print of table, which contains overall check results of all discontinuity regions in the project.
- **Materials** – switch on/off the print of table of used materials.
- **Cross-sections** – switch on/off the print of table of cross-sections characteristics.
- **Project items** – according to the current settings of **Items in report** individual discontinuity regions can be switched on/off to be printed into the report.
- **Explanations** - switch on/off print of explanations table.
- **Code and calculation settings** – switch on/off the print of code and calculation settings table.
- **Calculation presumptions** – switch on/off the print of calculation presumptions paragraph.

Group **Geometry**:

-  - switch on/off print of geometry pictures, in the specified scale .
-  - switch on/off print of the table describing the geometry of discontinuity region.
-  - switch on/off print of the pictures, which were inserted into the gallery when defining the geometry, in the specified scale.



#### Group **Loads**:

-  - switch on/off print of pictures of defined load combinations, in the specified scale.
  -  - input number of load pictures printed in one row.
-  - switch on/off print of tables describing defined external loads and defined internal forces.
-  - switch on/off print of pictures, which were inserted into the gallery when defining the loads, in the specified scale.
-  - switch on/off print of pictures and tables of load cases, contained in active load combinations.







#### Group **Topology optimization**:

-  - switch on/off print of pictures of topology optimization calculation results for all active loads and specified effective volume.

#### Group **Reinforcement**

-  - switch on/off print of reinforcement pictures, in the specified scale .
-  - switch on/off the print of pictures, which were inserted into the gallery when defining the reinforcement, in the specified scale.

#### Group **Results/Checks**

-  - switch to print brief results - only the summary check table is printed.
-  - switch to print selected results, pictures are printed in the specified scale and using the specified exceeded scale in Z-direction:
  - Group **Settings**
    -  - switch on/off print of labels of extreme values in check results pictures.
    -  - switch on/off print of corresponding values in tables of results.
  - Group **Concrete**:
    -  - switch on/off print of concrete stress to strength ratio picture.
    -  - switch on/off print of concrete principal stress  $\sigma_2$  picture.

- - switch on/off print of concrete principal strains ε1 and ε2 picture.
- - switch on/off print of concrete principal stresses directions picture.
- - switch on/off print of concrete compressive strength reduction factor kc picture.
- Group **Reinforcement**:
  - - switch on/off print of reinforcement strain to limit strain ratio picture.
  - - switch on/off print of reinforcement stress to limit stress ratio picture.
  - - switch on/off print of reinforcement stress picture.
  - - switch on/off print of reinforcement strain picture.
- Group **Anchorage**:
  - - switch on/off print of bond stress check picture.
  - - switch on/off print of anchorage force check picture.
  - - switch on/off print of anchorage force picture.
  - - switch on/off print of total force in reinforcement picture.
  - - switch on/off print of bond stress picture.
- Group **SLS**
  - - switch on/off print of concrete stress to concrete limit stress ratio picture.
  - - switch on/off print of crack width picture.
  - - switch on/off print of deflection check picture.
- - switch to print all detailed results, pictures are printed in the specified scale and using the specified exceeded scale in Z-direction.
- - switch on/off the print of pictures, which were inserted into the gallery when defining evaluating results, in the specified scale.

#### Group **Bill of material**

- - switch on/off print of pictures of reinforcement of discontinuity region.
- - switch on/off print of the bill of the material table.



## 9.2.5 Ribbon group Report view

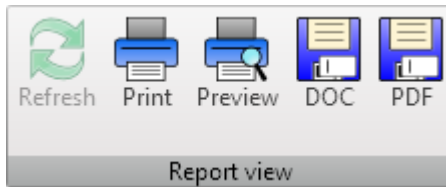

To print and export the report use commands in ribbon group **Report view**.

- **Refresh** – regenerate the report according to the current setting of report content
- **Print** –print of the report to the selected print device
- **Preview** – display print preview of the report
- **DOC** – save the report to the Microsoft Word file.
- **PDF**- save the report to the PDF file.

### 9.3 Cross-sections

Click navigator command **Project summary > Cross-sections** to display and edit cross-sections in the project.

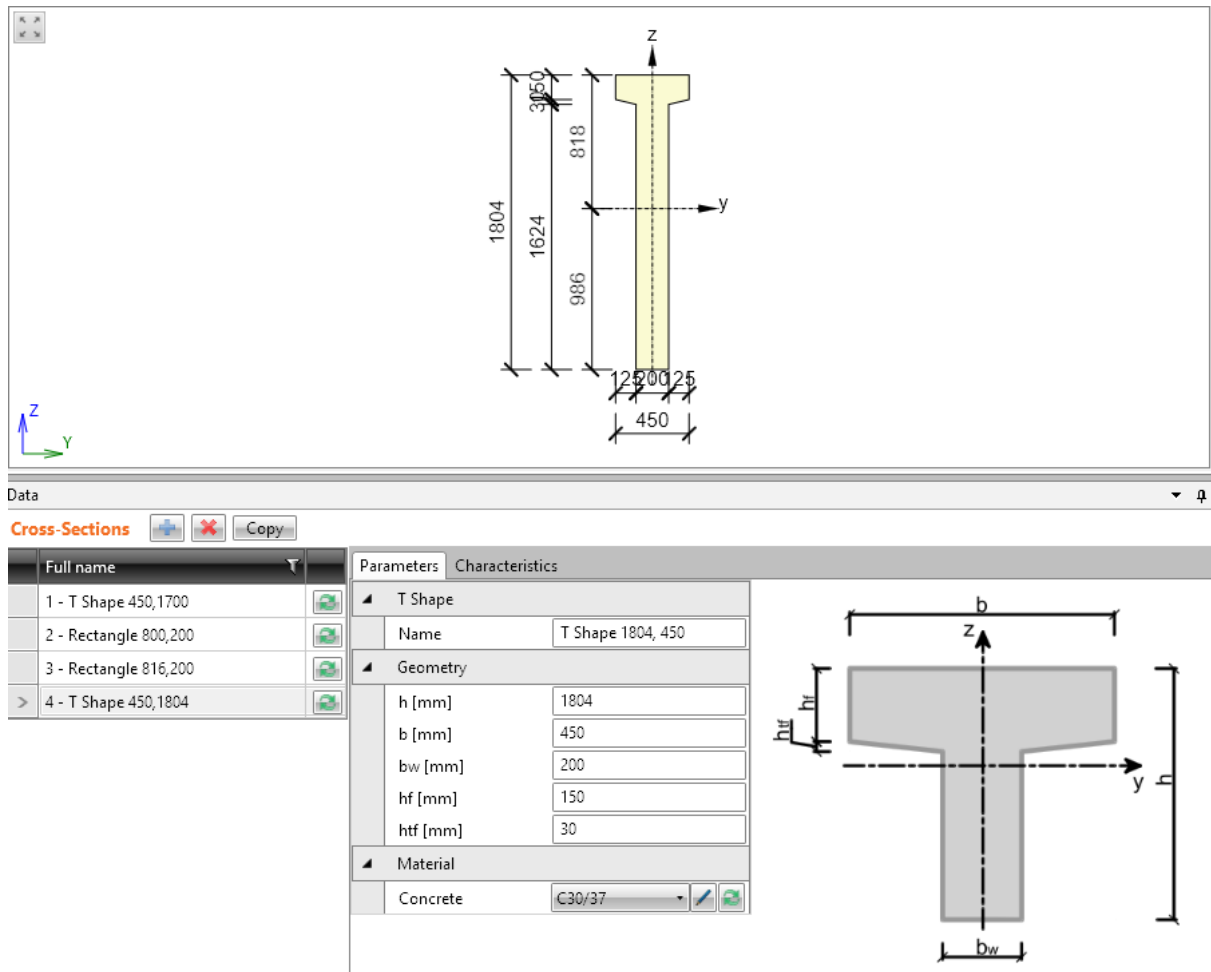

The screenshot displays the software interface for defining cross-sections. At the top, a 3D model of a T-shaped cross-section is shown with dimensions: total height 1804 mm, flange thickness 30 mm, flange width 450 mm, web width 200 mm, web height 818 mm, and a distance of 986 mm from the bottom of the web to the center of the flange. A coordinate system with Z (vertical), Y (horizontal), and X (depth) axes is shown.

Below the model is a 'Data' window with a 'Cross-Sections' table and a 'Parameters' panel.



Full name	Parameters	Characteristics
1 - T Shape 450,1700		
2 - Rectangle 800,200		
3 - Rectangle 816,200		
4 - T Shape 450,1804		

The 'Parameters' panel for the selected 'T Shape 1804, 450' is shown below:

T Shape	
Name	T Shape 1804, 450
Geometry	
h [mm]	1804
b [mm]	450
bw [mm]	200
hf [mm]	150
htf [mm]	30
Material	
Concrete	C30/37

To the right of the parameters is a 2D schematic of the T-shape with labels:  $b$  (flange width),  $z$  (vertical axis),  $hf$  (flange thickness),  $htf$  (web height),  $bw$  (web width), and  $y$  (horizontal axis).

Buttons above the **Cross-sections** table:

- **Copy** – create new cross-section by copying the current one.
-  - add new cross-section into the project.
-  - delete the current cross-section. The cross-section, which is assigned to any part of the structure, cannot be deleted.

Dialog **Cross-Section Navigator** appears with groups of cross-sections available for discontinuity region design.

Click the picture of required cross-section shape to add a new cross-section. The new cross-section is set as current cross-section and its property table is displayed in the data window.

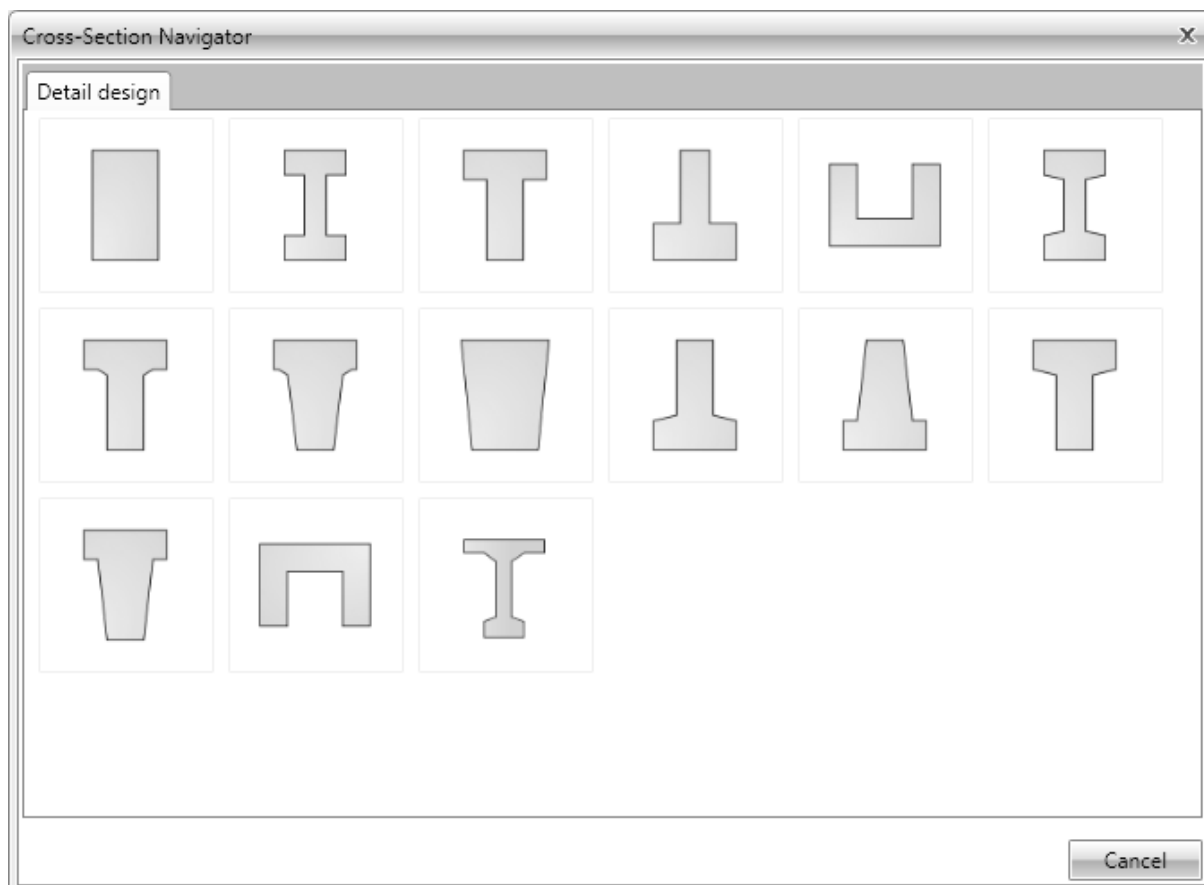

There is a list of already defined cross-sections in the left part of the data window. Following buttons are available for each cross-section:







-  - input a new cross-section. The current cross-section is replaced by the new one.

Properties of the current cross-section can be edited on the tab **Parameters** in the right part of the data table. Table of cross-sectional characteristics is displayed on the tab **Characteristics**.

## 9.4 Materials

Click navigator command **Project summary > Materials and models** to display and modify material characteristics and diagrams.

**Materials and constitutive models** Clean

Name	Type		
> C30/37	Concrete		
B 500B	Reinforcement st		
S 235	Steel		



EN 1992-1-1

fck [MPa]	30,0
Calculate depende	<input checked="" type="checkbox"/>
Ecm [MPa]	32836,6
fctm [MPa]	2,9
fctk,0,05 [MPa]	2,0
$\epsilon_{c2}$ [1e-4]	20,0
Exponent - n	2
Diagram type	Parabolic

EN 1992-1-1

$\epsilon_{cu2}$ [1e-4]	500,0
-------------------------	-------



All materials in the project are listed in the **Materials and constitutive models** table. Following buttons are available for each material:

-  - convert the material to the editable material. The name of material changes and the particular material characteristics can be edited. The change affects all cross-sections, which have assigned the edited material.
-  - display the dialog with the list of all materials available in the system material library. When a material from the library is selected, it replaces the edited material. The change affects all cross-sections, which have assigned the edited material.

**Clean** – the button is available if there is a material in the project, which is not assigned to any cross-section. Click the button to delete not used materials from the project.



## 9.5 Settings

Click navigator command **Project summary > Settings** to view and modify settings.



**Settings**  

Name	
> MD 1	





  









Parameters	
Name	MD 1
Reinforcement strategy	
Concrete cover [mm]	20
Vertical bars at surface	<input checked="" type="checkbox"/>
Minimum length of bars [mm]	300
Minimum length of stirrup branch [mm]	100
Default overhang over the opening [mm]	300
Default overhang over the opening as multiple diameter [-]	20,00
Default longitudinal bars anchorage type	
Default stirrups anchorage type	
Direction of concreting	Global Z +
Creep coefficient	2,5

Buttons above the **Settings** table:

-  - add new settings to the project.
-  - delete the current settings. Settings cannot be deleted if it is assigned to any structural member.

Properties group **Reinforcement strategy**:

- Concrete cover** – input default value of the thickness of the concrete cover.
- Vertical bars at surface** – if selected, vertical bars of wire fabrics are closer to the surface of wall than the horizontal bars. Otherwise the horizontal bars are closer to the surface.
- Minimum length of bars** – input minimal admissible length of reinforcement bar.
- Minimum length of stirrup branch** – input minimal admissible length of the stirrup branch.
- Default overhang over the opening** – input extension length of reinforcement bar over the opening edge.
- Default overhang over the opening as multiple of diameter** – input extension of reinforcement bar over the opening edge as a multiple of diameters.
- Default longitudinal bars anchorage type** – select default anchorage type at the beginning or end of the bar:
  -  - reinforcement bar ended with standard straight anchoring length.
  -  - reinforcement bar ended with a standard bend.
  -  - reinforcement bar ended with a standard hook.
  -  - reinforcement bar ended with loop.

-  - reinforcement bar ended with welded transversal bar.
-  - reinforcement bar considered to be with a perfect bond or continuous.
- **Default stirrups anchorage type:**
  -  - stirrup ended with standard straight anchoring length.
  -  - stirrup ended with standard hook.
  -  - stirrup ended with standard bend.
  -  - stirrup ended with two welded transversal bars.
  -  - stirrup with welded transversal bar.
  -  - stirrup bar considered to be with perfect bond or continuous.
  -  - stirrup ended with overlap of branches.
- **Direction of concreting** – select direction of concreting for calculation of bond conditions.
- **Creep coefficient** - input value of final creep coefficient at time interval ( $t_0=28$  days,  $t_{inf}$  = design working life)